



MENSHEN Weltweit
MENSHEN Worldwide



MENSHEN – SUSTAINABLE INNOVATIVE PACKAGING.

Unternehmensgeschichte

Tradition und Fortschritt werden bei MENSHEN seit über fünf Jahrzehnten groß geschrieben. Das inhabergeführte Unternehmen wurde im Jahr 1970 im sauerländischen Finnentrop gegründet und verfügt heute über insgesamt vierzehn Standorte in elf Ländern. Bereits zwei Jahre nach dem Firmenstart wurde mit Waldwick Plastics ein Standort in den USA gegründet. 1992 folgte die Eröffnung von MENSHEN Emballages in Frankreich. In den Folgejahren erweiterte sich die Unternehmensgruppe mit Produktions- und Vertriebsstandorten in Spanien, Mexiko, China, Singapur und der Schweiz.

Heute gehört MENSHEN zu den weltweit führenden Herstellern von Kunststoffverschlüssen und Systemverpackungen und beschäftigt rund 1.400 Mitarbeiter*innen auf der ganzen Welt.

Company History

Tradition and progress have typified MENSHEN for more than five decades. The owner-operated company was formed in 1970 in the city of Finnentrop in the Sauerland region and now has a total of 13 locations across eleven countries. A site was created in the USA within two years of the company's foundation in the form of Waldwick Plastics. The year 1992 saw the opening of MENSHEN UK Ltd. in the United Kingdom, and in 1992 came MENSHEN Emballage in France. Over the following years, the company expanded with production and sales sites in Spain, Mexico, China, Singapore, Hungary, Switzerland and Russia.

Today, MENSHEN is one of the world's leading manufacturers of plastic closures and system packaging and employs around 1,400 people around the world.



Philosophie

MENSHEN steht für Kompetenz, Individualität, Engagement und Nachhaltigkeit. Unserer weltweiten Verantwortung sind wir uns stets bewusst. Deshalb ist kundenorientiertes Denken und Handeln unser ständiger Antrieb. Ob individuelle Verschlusslösungen, komplexe Aufgabenstellungen oder höchste Sicherheitsansprüche – MENSHEN bietet seinen Kunden eine Zusammenarbeit ohne Kompromisse und Qualität ohne Abstriche.

Wir bei MENSHEN wissen: Die Zukunft bietet viele Möglichkeiten. Unser Anspruch ist es deshalb, uns stets weiterzuentwickeln und dynamisch auf die Anforderungen im Markt zu reagieren. Denn wer langfristig Maßstäbe setzen möchte, muss einen Schritt voraus sein. Dieses Ziel werden wir auch in Zukunft konsequent verfolgen, um unseren Kunden ein Höchstmaß an Vielseitigkeit und Fortschritt zu gewährleisten.

Philosophy

MENSHEN is renowned for expertise, individuality, dedication, and sustainability. We are constantly aware of our global responsibility. As a result, we are constantly motivated by customer-oriented thinking and actions. Be it individual closure solutions, complex tasks, or the highest safety standards, MENSHEN offers its customers collaboration and quality without compromise.

At MENSHEN, we know that the future brings many opportunities. It is therefore our mission continually to develop and respond dynamically to market requirements. In order to set new standards over the long term, it is necessary to be a step ahead of the industry. We will continue to strive toward this goal consistently in the future, so that we can ensure our customers a high level of versatility and technological progress.

VERSCHLÜSSE FÜR TUBEN // TUBE CLOSURES

1	Verschlüsse und Schwammaufträger für Flaschen und Tuben <i>Closing and Sponge Applications for Bottles and Tubes</i>	
1.1	FLASCHENVERSCHLÜSSE // CLOSURES FOR BOTTLES	
1.1.1	DOSIER-SCHRAUBVERSCHLÜSSE // DOSAGE SCREW CAPS	10
1.1.2	PUSH-PULL-VERSCHLÜSSE // PUSH-PULL CAPS	16
1.1.3	SCHRAUBVERSCHLÜSSE // SCREW CAPS	17
1.1.4	KLAPPSCHARNIER-SCHRAUBVERSCHLÜSSE // FLIP-TOP SCREW CAPS	23
1.1.5	KLAPPSCHARNIER-PRELLVERSCHLÜSSE // FLIP-TOP PUSH ON CAPS	26
1.1.6	KIPPEBEL-SCHRAUBVERSCHLÜSSE // TURRET SCREW CAPS	29
1.1.7	VERSCHLÜSSE FÜR TUBEN // TUBE CLOSURES	30
1.1.8	SCHWAMMAUFTRÄGER FÜR PASTÖSE FÜLLGÜTER // SPONGE APPLICATORS FOR VISCOUS FILLINGS	32
1.1.9	SCHWAMMAUFTRÄGER FÜR FLÜSSIGE FÜLLGÜTER // SPONGE APPLICATORS FOR LIQUID FILLINGS	34
	TECHNISCHE EIGENSCHAFTEN DER SCHWÄMME „PUR“ // TECHNICAL CHARACTERISTICS OF “PUR” MENSHEN SPONGES	36
1.1.10	KOMPLETTVERPACKUNGEN // COMPLETE PACKAGING	37
1.1.11	SONSTIGE VERPACKUNGEN // OTHER PACKAGING	38
2	Weldspouts für flexible Verpackungen <i>Weldspouts for Flexible Packaging</i>	
2.1.	FÜLLUNG DURCH BEUTEL // FILLING THROUGH POUCH	42
2.2.	FÜLLUNG DURCH WELDPOUT // FILLING THROUGH WELDPOUT	47
2.3.	FÜLLUNG DURCH BEUTEL UND DURCH WELDPOUT // FILLING THROUGH POUCH AND WELDPOUT	49
3	Chemieverschlüsse <i>Chemical Closures</i>	
3.	CHEMIEVERSCHLÜSSE // CHEMICAL CLOSURES	56
4	KAPSEL-LÖSUNGEN <i>CAPSULE SOLUTIONS</i>	
4.	KAPSEL-LÖSUNGEN // CAPSULE SOLUTIONS	66
5	TIEGEL UND DISPENSER <i>DECORATED JARS AND DISPENSERS</i>	
5.	TIEGEL UND DISPENSER // DECORATED JARS AND DISPENSERS	68

Unser Ziel für die Zukunft –

25% Rezyklat-Anteil in unserer Produktion

Our ambition for the future –

25% recyclates share in our production

▼
MENSHEN – SUSTAINABLE INNOVATIVE PACKAGING.





1

Verschlüsse und Schwammaufträger für Flaschen und Tuben *Closures and sponge applicators for bottles and tubes*

Überzeugende Designs, optimale Funktionalität, individuelle Lösungen – MENSHEN eröffnet eine Produktwelt, in der die Bedürfnisse der Kunden immer im Fokus stehen. Lassen Sie sich von der langjährigen Erfahrung und dem umfassenden Know-how unserer Mitarbeiter*innen überzeugen. MENSHEN bietet Ihnen ein vielfältiges Produktsortiment von bester Qualität im Bereich Verschlüsse und Schwammaufträger für Flaschen und Tuben.

Compelling designs, optimal functionality, and individual solutions – MENSHEN opens up a world of products where customer requirements always come first. Take advantage of the years of experience and comprehensive expertise of our employees. MENSHEN offers you an extensive range of closures and sponge applicators for bottles and tubes in the highest quality.

Optimale Lösungen für sauberes und einfaches Dosieren bieten die hochwertigen Dosier-Schraubverschlüsse. Durch ihre präzise Funktionalität eignen sie sich bestens für die Reinigungs- und Waschmittelindustrie.

The high-quality dosage screw closures provide optimal solutions for clean and simple dosage. They are ideally suited to the detergents industry thanks to their precise functionality.



Artikel links/Article left (33212..2) Seite 13/Page 13
Artikel rechts/Article right (33216..1) Seite 15/Page 15

DOSIER-SCHRAUBVERSCHLÜSSE // DOSAGE SCREW CAPS

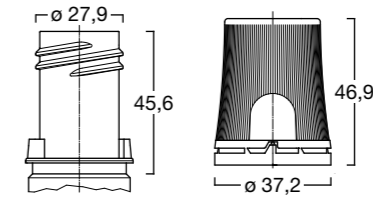

Artikel-Nr. article no.	Material material	Anbringungsart fixing type	Gewindegröße thread size	Dosiervolumen dosage volume	Dichtung seal	Originalitätsverschluss tamper evidence	Kindersicherung child resistance	Entgasung venting device
52099..1	PE	Schraubversion screw version	28 mm	25 ml	Konus cone	■	■	-

DOSIER-SCHRAUBVERSCHLÜSSE // DOSAGE SCREW CAPS

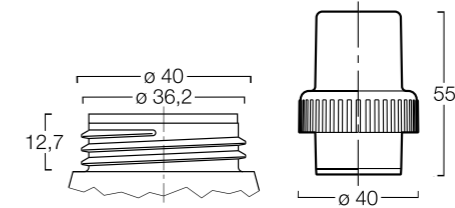

Artikel-Nr. article no.	Material material	Anbringungsart fixing type	Gewindegröße thread size	Dosiervolumen dosage volume	Dichtung seal	Originalitätsverschluss tamper evidence	Kindersicherung child resistance	Entgasung venting device
12004..1	PP	Schraubversion screw version	36 mm	30 ml	Konus cone	-	-	-

DOSIER-SCHRAUBVERSCHLÜSSE // DOSAGE SCREW CAPS

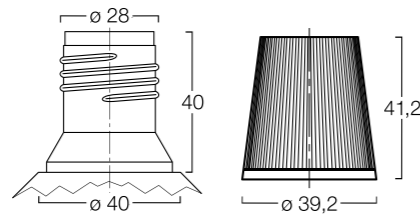

Artikel-Nr. article no.	Material material	Anbringungsart fixing type	Gewindegröße thread size	Dosiervolumen dosage volume	Dichtung seal	Originalitätsverschluss tamper evidence	Kindersicherung child resistance	Entgasung venting device
11270..1	PP	Schraubversion screw version	28 mm	30 ml	Konus cone	-	-	-

DOSIER-SCHRAUBVERSCHLÜSSE // DOSAGE SCREW CAPS

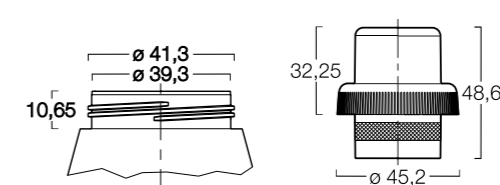

Artikel-Nr. article no.	Material material	Anbringungsart fixing type	Gewindegröße thread size	Dosiervolumen dosage volume	Dichtung seal	Originalitätsverschluss tamper evidence	Kindersicherung child resistance	Entgasung venting device
12957..1	PP	Schraubversion screw version	42 mm	30 ml	Konus cone	-	-	-

DOSIER-SCHRAUBVERSCHLÜSSE // DOSAGE SCREW CAPS

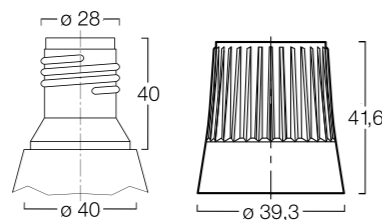

Artikel-Nr. article no.	Material material	Anbringungsart fixing type	Gewindegröße thread size	Dosiervolumen dosage volume	Dichtung seal	Originalitätsverschluss tamper evidence	Kindersicherung child resistance	Entgasung venting device
12664..1	PP	Schraubversion screw version	28 mm	30 ml	Konus cone	-	-	-

DOSIER-SCHRAUBVERSCHLÜSSE // DOSAGE SCREW CAPS

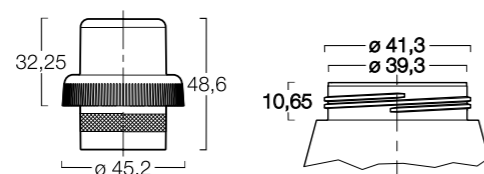

Artikel-Nr. article no.	Material material	Anbringungsart fixing type	Gewindegröße thread size	Dosiervolumen dosage volume	Dichtung seal	Originalitätsverschluss tamper evidence	Kindersicherung child resistance	Entgasung venting device
22097..1	PP	Schraubversion screw version	42 mm	30 ml	Konus cone	-	-	■

DOSIER-SCHRAUBVERSCHLÜSSE // DOSAGE SCREW CAPS

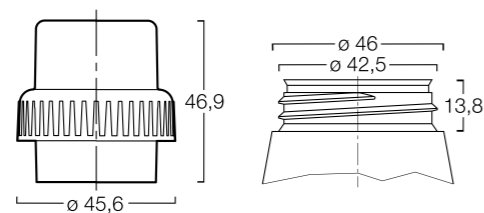

Artikel-Nr. article no.	Material material	Anbringungsart fixing type	Gewindegröße thread size	Dosiervolumen dosage volume	Dichtung seal	Originalitätsverschluss tamper evidence	Kindersicherung child resistance	Entgasung venting device
12542..1	PP	Schraubversion screw version	43 mm	40 ml	Konus cone	-	-	-

DOSIER-SCHRAUBVERSCHLÜSSE // DOSAGE SCREW CAPS

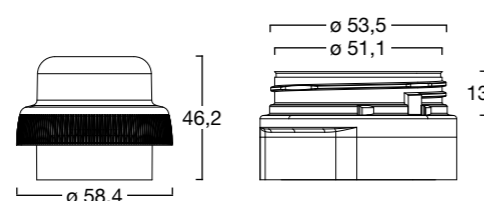

Artikel-Nr. article no.	Material material	Anbringungsart fixing type	Gewindegröße thread size	Dosiervolumen dosage volume	Dichtung seal	Originalitätsverschluss tamper evidence	Kindersicherung child resistance	Entgasung venting device
12715..1	PP	Schraubversion screw version	53 mm	60 ml	Konus cone	-	-	-

DOSIER-SCHRAUBVERSCHLÜSSE // DOSAGE SCREW CAPS

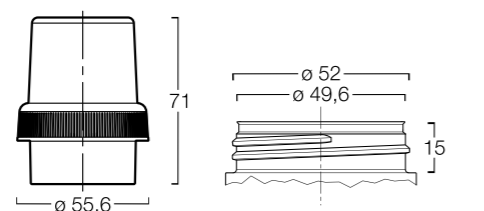

Artikel-Nr. article no.	Material material	Anbringungsart fixing type	Gewindegröße thread size	Dosiervolumen dosage volume	Dichtung seal	Originalitätsverschluss tamper evidence	Kindersicherung child resistance	Entgasung venting device
11866..1	PP	Schraubversion screw version	53 mm	100 ml	Konus cone	-	-	-

ZWEITEILIGER DOSIER-SCHRAUBVERSCHLUSS // TWO PART DOSAGE SCREW CAP

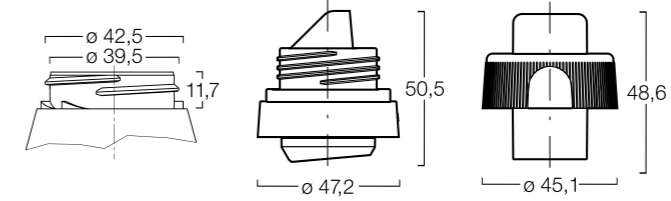

Messbecher mit Ausgießer montiert
doser with pourer assembled

Artikel-Nr. article no.	Material Dosierer material dosage	Material Ausgießer material pourer	Anbringungsart fixing type	Gewindegröße thread size	Dosiervolumen dosage volume	Dichtung seal	Originalitätsverschluss tamper evidence	Kindersicherung child resistance	Entgasung venting device
33304..1	PP 1816	PP 1817	Schraubversion screw version	42 mm	20 ml	Konus cone	-	■	-

ZWEITEILIGER DOSIER-SCHRAUBVERSCHLUSS // TWO PART DOSAGE SCREW CAP

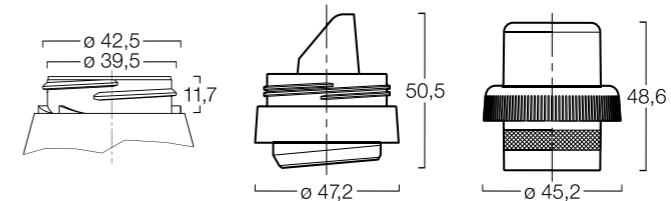

Messbecher mit Ausgießer montiert
doser with pourer assembled

Artikel-Nr. article no.	Material Dosierer material dosage	Material Ausgießer material pourer	Anbringungsart fixing type	Gewindegröße thread size	Dosiervolumen dosage volume	Dichtung seal	Originalitätsverschluss tamper evidence	Kindersicherung child resistance	Entgasung venting device
34216..1	PP 2097	PP 2956	Schraubversion screw version	42 mm	30 ml	Konus cone	-	-	■

ZWEITEILIGER DOSIER-SCHRAUBVERSCHLUSS // TWO PART DOSAGE SCREW CAP

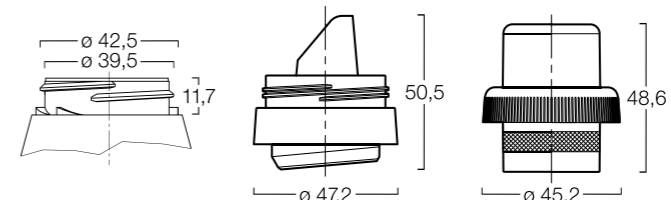

Messbecher mit Ausgießer montiert
doser with pourer assembled

Artikel-Nr. article no.	Material Dosierer material dosage	Material Ausgießer material pourer	Anbringungsart fixing type	Gewindegröße thread size	Dosiervolumen dosage volume	Dichtung seal	Originalitätsverschluss tamper evidence	Kindersicherung child resistance	Entgasung venting device
33216..1	PP 2957	PP 2956	Schraubversion screw version	42 mm	30 ml	Konus cone	-	-	-

ZWEITEILIGER DOSIER-SCHRAUBVERSCHLUSS // TWO PART DOSAGE SCREW CAP

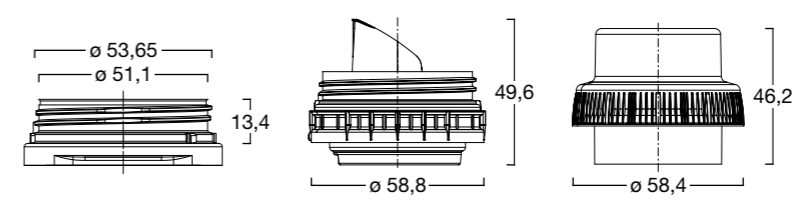

Artikel-Nr. article no.	Material Dosierer material dosage	Material Ausgießer material pourer	Anbringungsart fixing type	Gewindegröße thread size	Dosiervolumen dosage volume	Dichtung seal	Originalitätsverschluss tamper evidence	Kindersicherung child resistance	Entgasung venting device
33217..1	PP	PE	Schraubversion screw version	53 mm	60 ml	Konus cone	-	-	-

Eine funktionale Präzision, einfache Handhabung und garantierte Dichtheit bieten die Push-Pull-Verschlüsse. Gerne beraten wir Sie bei der Wahl des richtigen Verschlusses.

Push-pull closures offer precision, simple handling, and guaranteed seal tightness. We would be happy to help you choose the right closure.



PUSH-PULL-VERSCHLÜSSE // PUSH-PULL CAPS

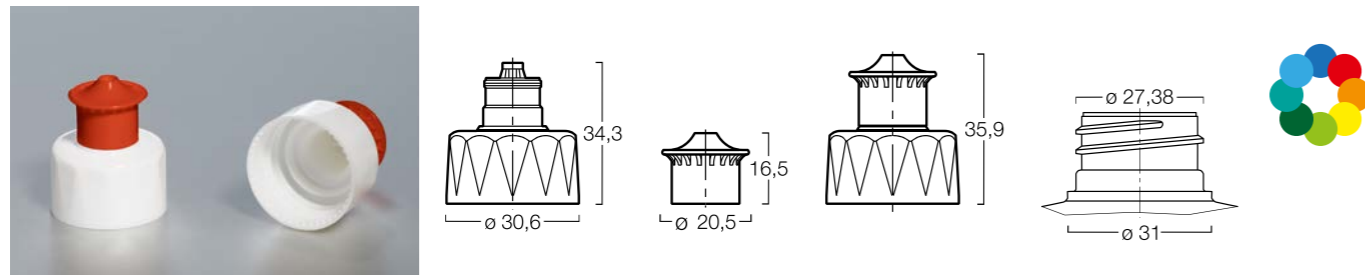

Artikel-Nr. article no.	Material Oberteil material upper part	Material Unterteil material base part	Anbringungsart fixing type	Gewindegröße thread size	Austrittsöffnung orifice size	Dichtung seal
52060..A	PE	PP	Schraubversion screw version	28 / 410	1 mm	Konus cone
52060..B	PE	PP	Schraubversion screw version	28 / 410	2,5 mm	Konus cone
52060..C	PE	PP	Schraubversion screw version	28 / 410	3,5 mm	Konus cone
52060..D	PE	PP	Schraubversion screw version	28 / 410	4,5 mm	Konus cone
35109..E	PE	PP	Schraubversion screw version	28 / 410	3 mm	Konus cone

SCHRAUBVERSCHLÜSSE // SCREW CAPS

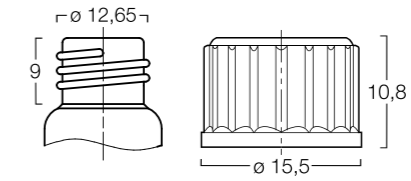

Artikel-Nr. article no.	Material material	Anbringungsart fixing type	Gewindegröße thread size	Austrittsöffnung orifice size	Dichtung seal	Originalitätsverschluss tamper evidence	Kindersicherung child resistance	Entgasung venting device
11603..1	PE	Schraubversion screw version	13 mm	-	Konus cone	-	-	-

SCHRAUBVERSCHLÜSSE // SCREW CAPS

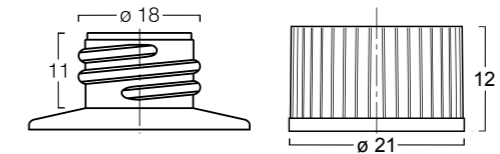

Artikel-Nr. article no.	Material material	Anbringungsart fixing type	Gewindegröße thread size	Austrittsöffnung orifice size	Dichtung seal	Originalitätsverschluss tamper evidence	Kindersicherung child resistance	Entgasung venting device
12837..1	PP	Schraubversion screw version	18 mm	-	Konus cone	-	-	-

SCHRAUBVERSCHLÜSSE // SCREW CAPS

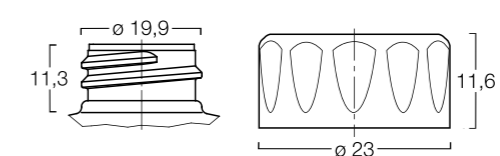

Artikel-Nr. article no.	Material material	Anbringungsart fixing type	Gewindegröße thread size	Austrittsöffnung orifice size	Dichtung seal	Originalitätsverschluss tamper evidence	Kindersicherung child resistance	Entgasung venting device
12169..1	PP	Schraubversion screw version	20 / 400	-	Konus cone	-	-	-

SCHRAUBVERSCHLÜSSE // SCREW CAPS

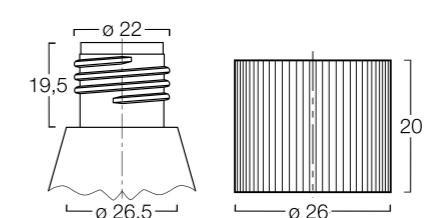

Artikel-Nr. article no.	Material material	Anbringungsart fixing type	Gewindegröße thread size	Austrittsöffnung orifice size	Dichtung seal	Originalitätsverschluss tamper evidence	Kindersicherung child resistance	Entgasung venting device
11380..1	PE	Schraubversion screw version	22 mm	-	Konus cone	-	-	-

SCHRAUBVERSCHLÜSSE // SCREW CAPS

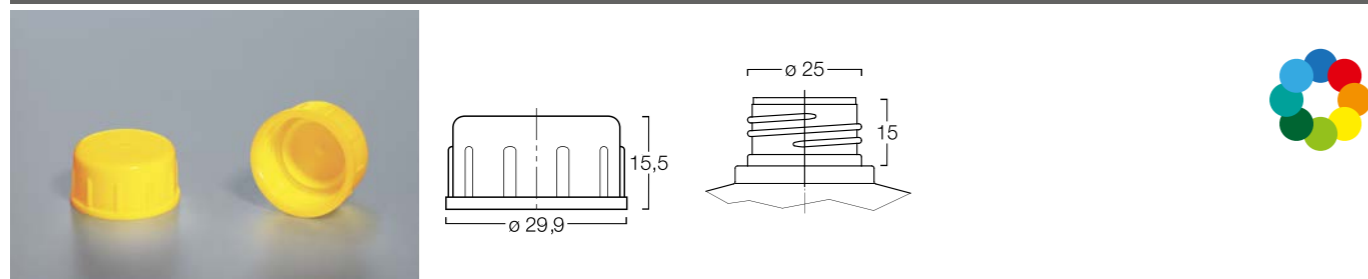

Artikel-Nr. article no.	Material material	Anbringungsart fixing type	Gewindegröße thread size	Austrittsöffnung orifice size	Dichtung seal	Originalitätsverschluss tamper evidence	Kindersicherung child resistance	Entgasung venting device
10640..1	PE	Schraubversion screw version	25 mm	-	Konus cone	-	-	-

SCHRAUBVERSCHLÜSSE // SCREW CAPS

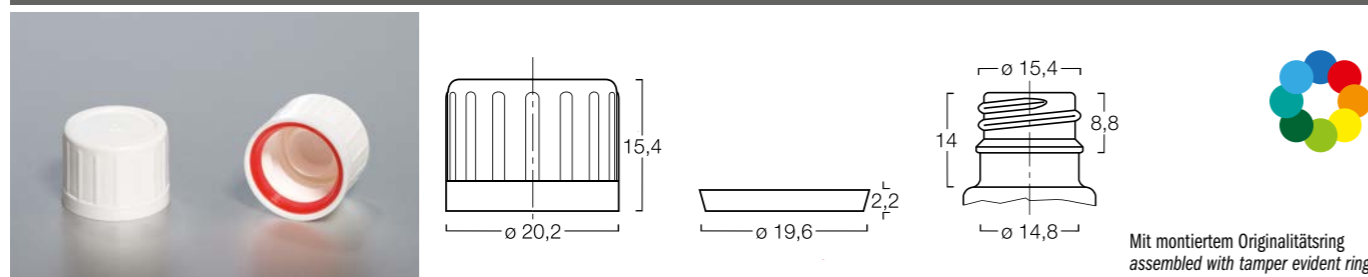

Artikel-Nr. article no.	Material Verschluss material closure	Material Ring material ring	Anbringungsart fixing type	Gewindegröße thread size	Austrittsöffnung orifice size	Dichtung seal	Originalitätsverschluss tamper evidence	Kindersicherung child resistance	Entgasung venting device
31210..1	PP	PP	Schraubversion screw version	16 mm	-	Konus cone	■	-	-
31209..1	PP	PP	Schraubversion screw version	16 mm	-	-	■	-	-

SCHRAUBVERSCHLÜSSE // SCREW CAPS

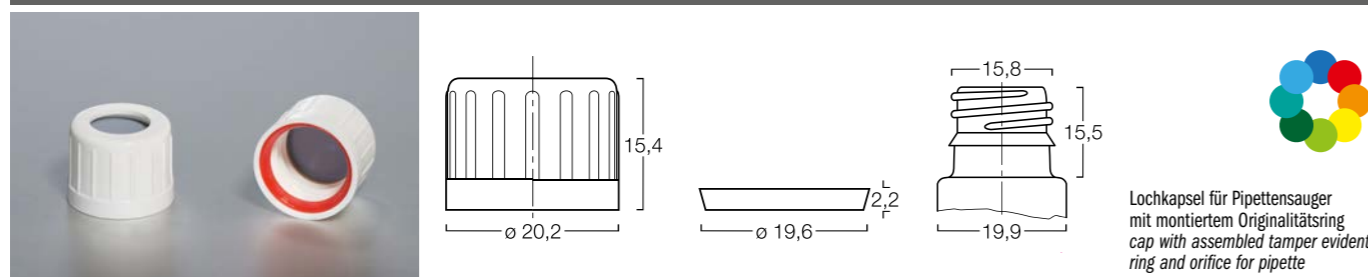

Artikel-Nr. article no.	Material Verschluss material closure	Material Ring material ring	Anbringungsart fixing type	Gewindegröße thread size	Lochgröße bore size	Dichtung seal	Originalitätsverschluss tamper evidence	Kindersicherung child resistance	Entgasung venting device
31206..1	PP	PP	Schraubversion screw version	16 mm	11,5 mm	-	■	-	-

SCHRAUBVERSCHLÜSSE // SCREW CAPS

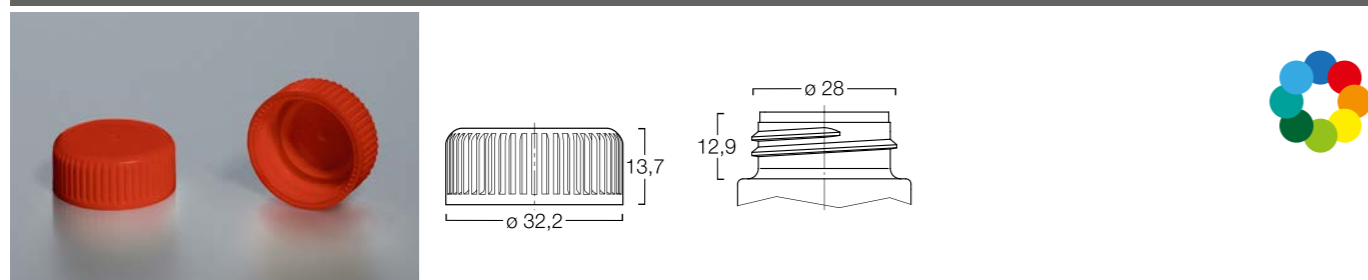

Artikel-Nr. article no.	Material material	Anbringungsart fixing type	Gewindegröße thread size	Austrittsöffnung orifice size	Dichtung seal	Originalitätsverschluss tamper evidence	Kindersicherung child resistance	Entgasung venting device
52125..1	PP	Schraubversion screw version	28 mm	-	Konus cone	-	-	-

SCHRAUBVERSCHLÜSSE // SCREW CAPS

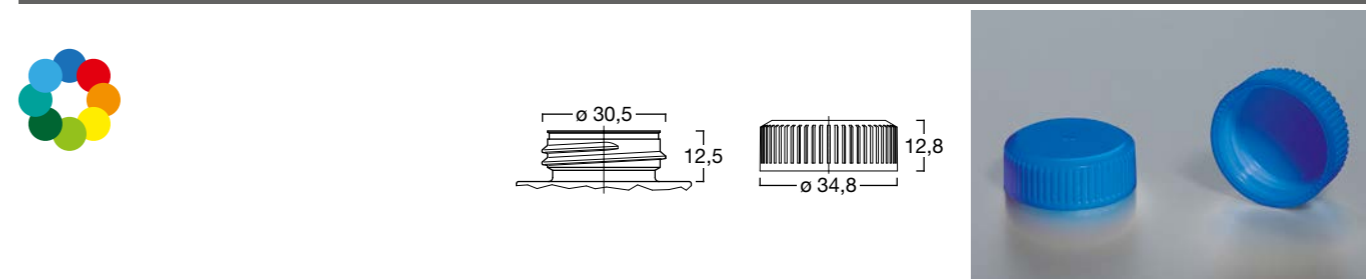

Artikel-Nr. article no.	Material material	Anbringungsart fixing type	Gewindegröße thread size	Austrittsöffnung orifice size	Dichtung seal	Originalitätsverschluss tamper evidence	Kindersicherung child resistance	Entgasung venting device
11299..1	PP	Schraubversion screw version	30 mm	-	Konus cone	-	-	-
21429..1	PP	Schraubversion screw version	30 mm	-	Einlage liner	-	-	-

SCHRAUBVERSCHLÜSSE // SCREW CAPS

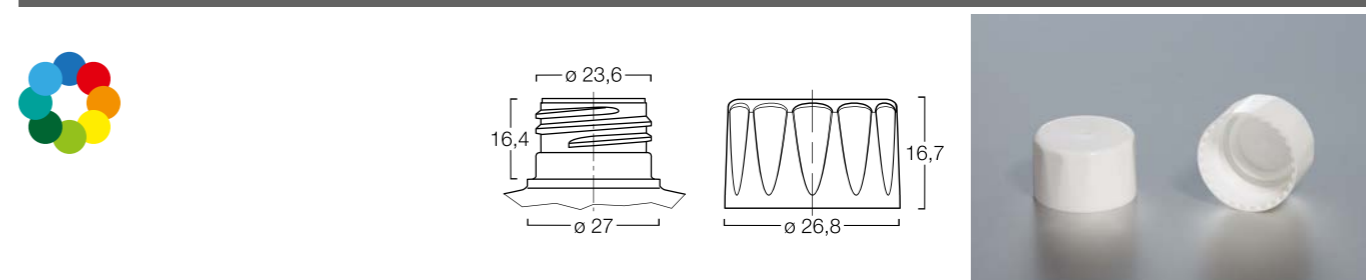

Artikel-Nr. article no.	Material material	Anbringungsart fixing type	Gewindegröße thread size	Austrittsöffnung orifice size	Dichtung seal	Originalitätsverschluss tamper evidence	Kindersicherung child resistance	Entgasung venting device
12602..1	PP	Schraubversion screw version	24 / 410	-	Konus cone	-	-	-

SCHRAUBVERSCHLÜSSE // SCREW CAPS

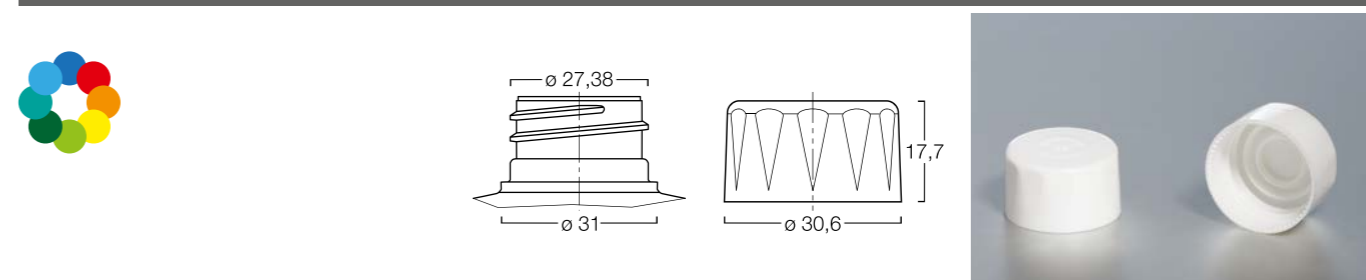

Artikel-Nr. article no.	Material material	Anbringungsart fixing type	Gewindegröße thread size	Austrittsöffnung orifice size	Dichtung seal	Originalitätsverschluss tamper evidence	Kindersicherung child resistance	Entgasung venting device
21916..1	PP	Schraubversion screw version	28 / 410	-	Konus cone	-	-	■

SCHRAUBVERSCHLÜSSE // SCREW CAPS

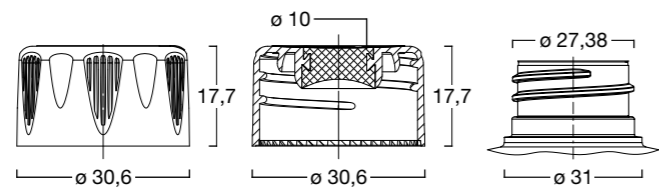

Wachsverschluss - für Reinigungsmittel
in Geschirrspülmaschine
Wax Cap - for detergents for
dishwashers



Artikel-Nr. article no.	Material material	Anbringungsart fixing type	Gewindegröße thread size	Austrittsöffnung orifice size	Dichtung seal	Originalitätsverschluss tamper evidence	Kindersicherung child resistance	Entgasung venting device
22918..1	PP	Schraubversion screw version	28 / 410	-	Konus cone	-	-	-

SCHRAUBVERSCHLÜSSE // SCREW CAPS

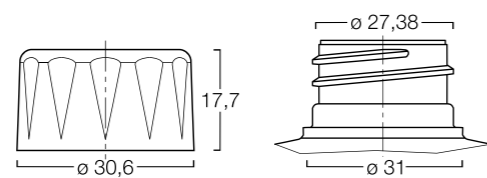

Artikel-Nr. article no.	Material material	Anbringungsart fixing type	Gewindegröße thread size	Austrittsöffnung orifice size	Dichtung seal	Originalitätsverschluss tamper evidence	Kindersicherung child resistance	Entgasung venting device
11794..1	PP	Schraubversion screw version	28 / 410	-	Konus cone	-	-	-

SCHRAUBVERSCHLÜSSE // SCREW CAPS

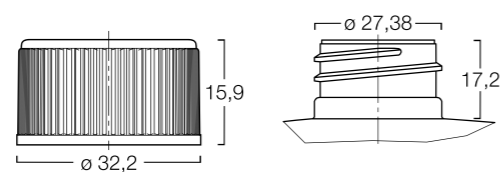

Öffnungsprinzip: drücken und drehen
opening by press and turn



Artikel-Nr. article no.	Material Oberteil material upper part	Material Unterteil material lower part	Anbringungsart fixing type	Gewindegröße thread size	Austrittsöffnung orifice size	Dichtung seal	Originalitätsverschluss tamper evidence	Kindersicherung child resistance	Entgasung venting device
31602..1	PP	PP	Schraubversion screw version	28 / 410	-	Einlage liner	-	■	-
31606..2	PP	PP	Schraubversion screw version	28 / 410	-	Konus cone	-	■	-
31602..4	PP	PP	Schraubversion screw version	28 / 410	-	Konus cone	-	■	■
MIT PE-SPRITZER MONTIERT // WITH PE-PLUG ASSEMBLED									
31602..3	PP	PP	Schraubversion screw version	28 / 410	2 mm	Dorn spigot	-	■	-

SCHRAUBVERSCHLÜSSE // SCREW CAPS

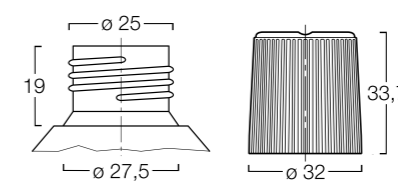

Öffnungsprinzip: drücken und drehen
press and turn to open



Artikel-Nr. article no.	Material Außenteil material outside part	Material Innenteil material inner part	Material Spritzer material plug	Anbringungsart fixing type	Gewindegröße thread size	Austrittsöffnung orifice size	Dichtung seal	Kindersicherung child resistance	Entgasung venting device
33302..1	PP	PP	PE	Schraubversion screw version	25 mm	3 mm	Dorn spigot	■	-

APPLIKATOR-VERSCHLÜSSE // APPLICATORS

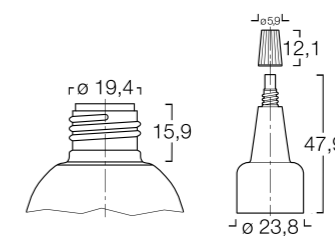

Applikator, montiert
applicator, assembled



Artikel-Nr. article no.	Material Verschluss material closure	Material Kappe material cap	Anbringungsart fixing type	Gewindegröße thread size	Austrittsöffnung orifice size	Dichtung seal	Originalitätsverschluss tamper evidence	Kindersicherung child resistance	Entgasung venting device
33715..1	PP	PP	Schraubversion screw version	19 mm	1 mm	Konus cone	-	-	-
33715..2	PP	PP	Schraubversion screw version	19 mm	2 mm	Konus cone	-	-	-
33715..3	PP	PP	Schraubversion screw version	19 mm	0,8 mm	Konus cone	-	-	-
33715..4	PP	PP	Schraubversion screw version	19 mm	0,5 mm	Konus cone	-	-	-

APPLIKATOR-VERSCHLÜSSE // APPLICATORS

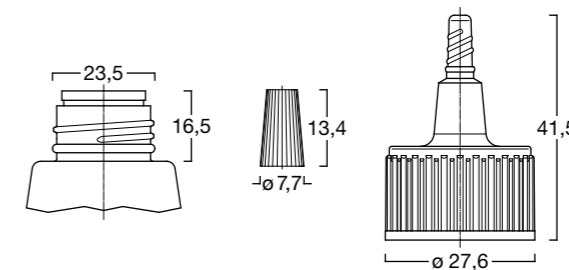

Applikator, montiert
applicator, assembled



Artikel-Nr. article no.	Material Verschluss material closure	Material Kappe material cap	Anbringungsart fixing type	Gewindegröße thread size	Austrittsöffnung orifice size	Dichtung seal	Originalitätsverschluss tamper evidence	Kindersicherung child resistance	Entgasung venting device
33713..1	PE	PE	Schraubversion screw version	24 mm	2 mm	Konus cone	-	-	-

APPLIKATOR-VERSCHLÜSSE // APPLICATORS

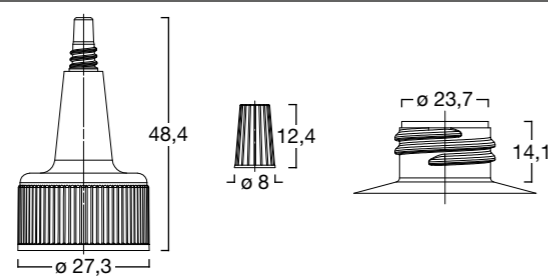

Applikator, montiert
applicator, assembled

Artikel-Nr. article no.	Material Verschluss material closure	Material Kappe material cap	Anbringungsart fixing type	Gewindegröße thread size	Austrittsöffnung orifice size	Dichtung seal	Originalitätsverschluss tamper evidence	Kindersicherung child resistance	Entgasung venting device
33712..2	PP	PE	Schraubversion screw version	24 mm	2 mm	Konus cone	-	-	-

APPLIKATOR-VERSCHLÜSSE // APPLICATORS

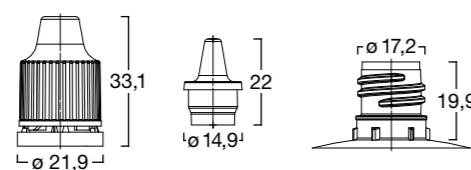

Spritzer und Kappe nicht montiert
plug and cap not assembled

Artikel-Nr. article no.	Material Verschluss material closure	Material Spritzer material plug	Anbringungsart fixing type	Gewindegröße thread size	Austrittsöffnung orifice size	Dichtung seal	Originalitätsverschluss tamper evidence	Kindersicherung child resistance	Entgasung venting device
12459..1	-	PE	-	-	1 mm	Konus cone	-	-	-
12460..1	PP	-	Schraubversion screw version	17 mm	-	Dorn spigot	■	-	-

Für unterschiedlichste Füllgüter eignen sich die Klappscharnier-Verschlüsse von MENSHEN. Durch eine präzise Fertigung wird absolute Dichtheit sowie Zuverlässigkeit garantiert.

MENSHEN flip-top closures are suitable for a wide range of filling contents. With their precise production, absolute seal tightness and reliability are guaranteed.



Artikel/Article (12851..1) Seite 28/Page 28

KLAPPSCHARNIER-SCHRAUBVERSCHLÜSSE // FLIP-TOP SCREW CAPS

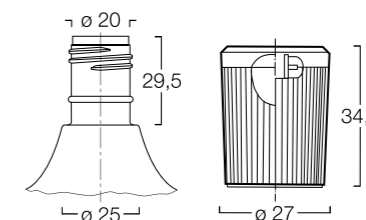

Artikel-Nr. article no.	Material material	Anbringungsart fixing type	Gewindegröße thread size	Austrittsöffnung orifice size	Dichtung seal	Originalitätsverschluss tamper evidence	Kindersicherung child resistance	Entgasung venting device
11110..1	PP	Schraubversion screw version	20 mm	2 mm	Konus cone	-	-	-

KLAPPSCHARNIER-SCHRAUBVERSCHLÜSSE // FLIP-TOP SCREW CAPS

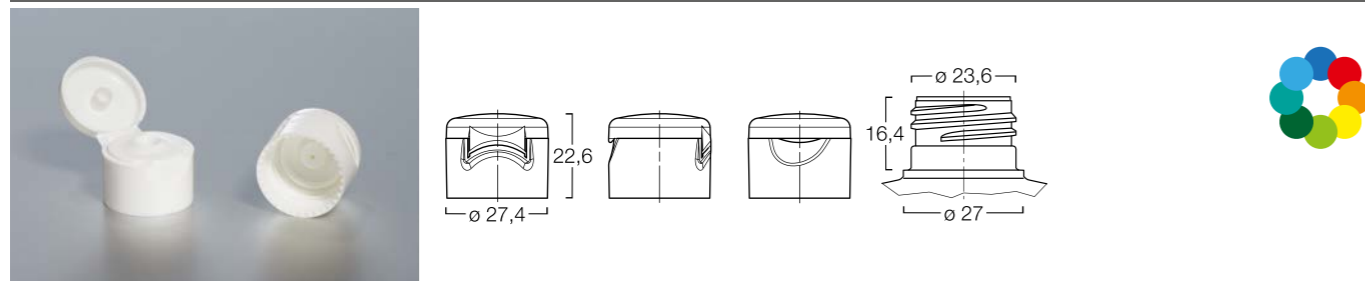

Artikel-Nr. article no.	Material material	Anbringungsart fixing type	Gewindegröße thread size	Austrittsöffnung orifice size	Dichtung seal	Originalitätsverschluss tamper evidence	Kindersicherung child resistance	Entgasung venting device
12826.1	PP	Schraubversion screw version	24 / 410	1,5 mm	Konus cone	-	-	-
12826.3	PP	Schraubversion screw version	24 / 410	3 mm	Konus cone	-	-	-
12826.2	PP	Schraubversion screw version	24 / 410	4,4 mm	Konus cone	-	-	-
52128.1	PP	Schraubversion screw version	24 / 410	3 mm	Konus cone	-	-	-
52128.2	PP	Schraubversion screw version	24 / 410	1,5 mm	Konus cone	-	-	-
52128.3	PP	Schraubversion screw version	24 / 410	4,4 mm	Konus cone	-	-	-

KLAPPSCHARNIER-SCHRAUBVERSCHLÜSSE // FLIP-TOP SCREW CAPS

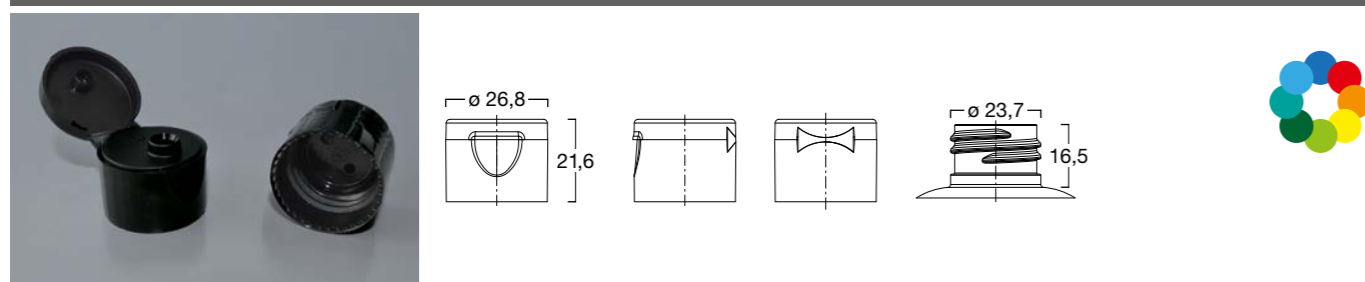

Artikel-Nr. article no.	Material material	Anbringungsart fixing type	Gewindegröße thread size	Austrittsöffnung orifice size	Dichtung seal	Originalitätsverschluss tamper evidence	Kindersicherung child resistance	Entgasung venting device
12832.1	PP	Schraubversion screw version	24 / 410	3 mm	Konus cone	-	-	-

KLAPPSCHARNIER-SCHRAUBVERSCHLÜSSE // FLIP-TOP SCREW CAPS

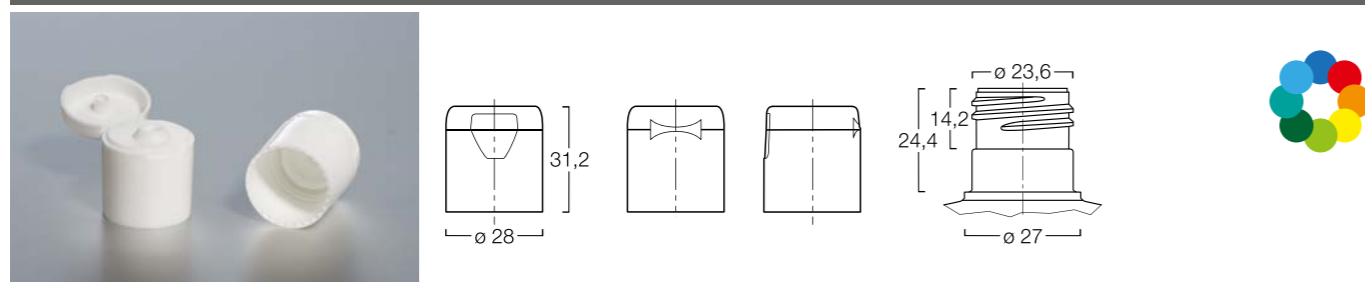

Artikel-Nr. article no.	Material material	Anbringungsart fixing type	Gewindegröße thread size	Austrittsöffnung orifice size	Dichtung seal	Originalitätsverschluss tamper evidence	Kindersicherung child resistance	Entgasung venting device
12848.1	PP	Schraubversion screw version	24 / 415	4 mm	Konus cone	-	-	-
12848.3	PP	Schraubversion screw version	24 / 415	2 mm	Konus cone	-	-	-

KLAPPSCHARNIER-SCHRAUBVERSCHLÜSSE // FLIP-TOP SCREW CAPS

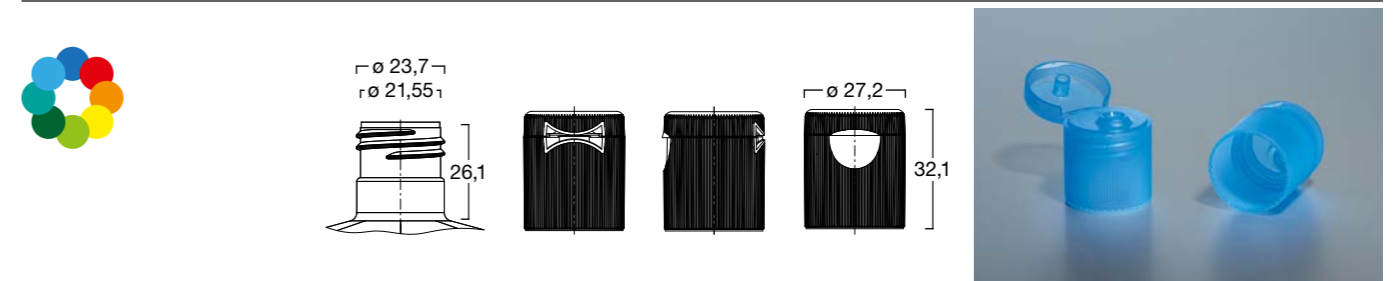

Artikel-Nr. article no.	Material material	Anbringungsart fixing type	Gewindegröße thread size	Austrittsöffnung orifice size	Dichtung seal	Originalitätsverschluss tamper evidence	Kindersicherung child resistance	Entgasung venting device
12830.1	PP	Schraubversion screw version	24 / 415	4,5 mm	Konus cone	-	-	-

KLAPPSCHARNIER-SCHRAUBVERSCHLÜSSE // FLIP-TOP SCREW CAPS

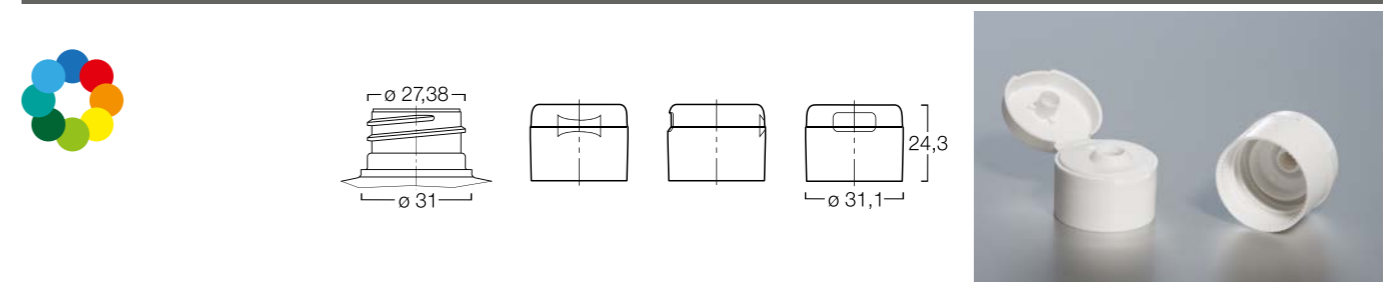

Artikel-Nr. article no.	Material material	Anbringungsart fixing type	Gewindegröße thread size	Austrittsöffnung orifice size	Dichtung seal	Originalitätsverschluss tamper evidence	Kindersicherung child resistance	Entgasung venting device
12972.1	PP	Schraubversion screw version	28 / 410	2,4,6 mm	Konus cone	-	-	-

KLAPPSCHARNIER-SCHRAUBVERSCHLÜSSE // FLIP-TOP SCREW CAPS

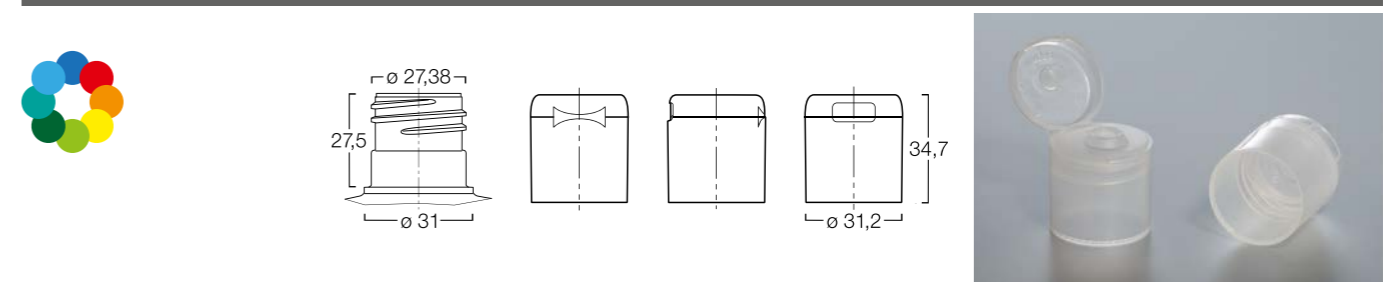

Artikel-Nr. article no.	Material material	Anbringungsart fixing type	Gewindegröße thread size	Austrittsöffnung orifice size	Dichtung seal	Originalitätsverschluss tamper evidence	Kindersicherung child resistance	Entgasung venting device
12035.1	PP	Schraubversion screw version	28 / 415	6 mm	Konus cone	-	-	-

KLAPPSCHARNIER-SCHRAUBVERSCHLÜSSE // FLIP-TOP SCREW CAPS

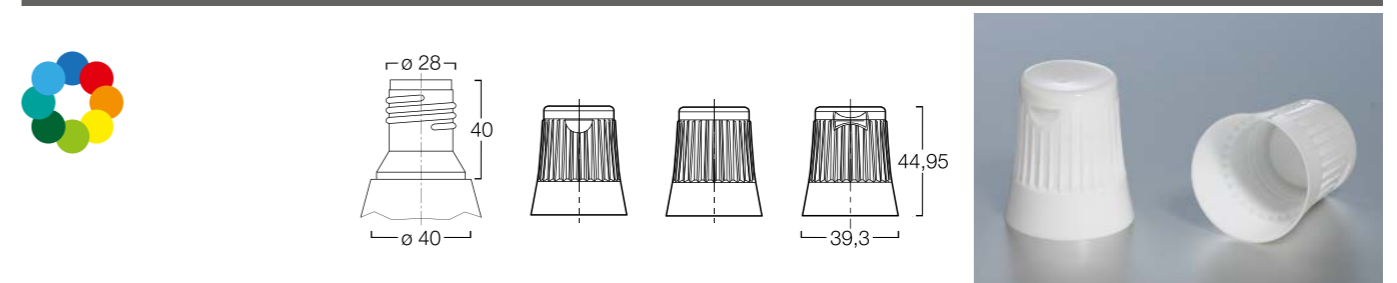

Artikel-Nr. article no.	Material material	Anbringungsart fixing type	Gewindegröße thread size	Austrittsöffnung orifice size	Dichtung seal	Originalitätsverschluss tamper evidence	Kindersicherung child resistance	Entgasung venting device
11863.1	PP	Schraubversion screw version	28 mm	4 mm	Konus cone	-	-	-

KLAPPSCHARNIER-PRELLVERSCHLÜSSE // FLIP-TOP PUSH ON CAPS

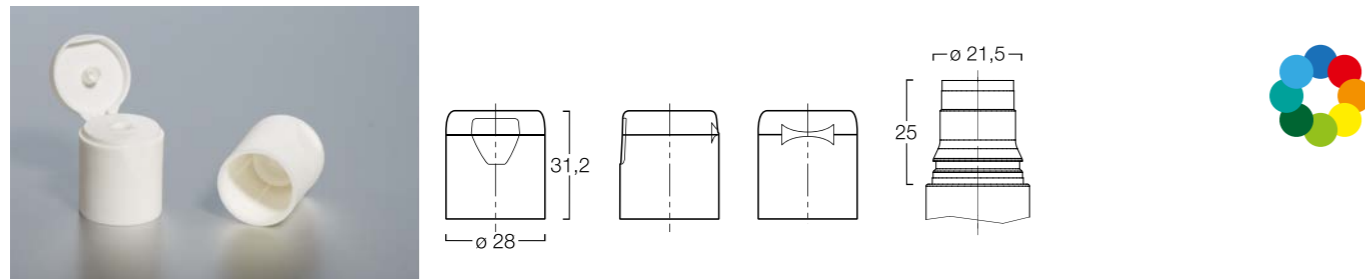

Artikel-Nr. article no.	Material material	Anbringungsart fixing type	Gewindegröße thread size	Austrittsöffnung orifice size	Dichtung seal	Originalitätsverschluss tamper evidence	Kindersicherung child resistance	Entgasung venting device
52057..1	PP	Prellversion push on version	-	3,5 mm	Konus cone	-	-	-

KLAPPSCHARNIER-PRELLVERSCHLÜSSE // FLIP-TOP PUSH ON CAPS

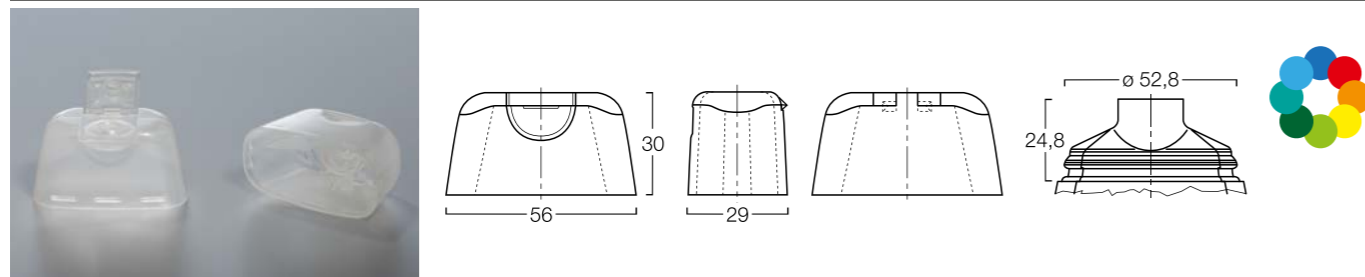

Artikel-Nr. article no.	Material material	Anbringungsart fixing type	Gewindegröße thread size	Austrittsöffnung orifice size	Dichtung seal	Originalitätsverschluss tamper evidence	Kindersicherung child resistance	Entgasung venting device
11809..1	PP	Prellversion push on version	-	7 mm	Konus cone	-	-	-
11809..2	PP	Prellversion push on version	-	3 mm	Konus cone	-	-	-

KLAPPSCHARNIER-PRELLVERSCHLÜSSE // FLIP-TOP PUSH ON CAPS

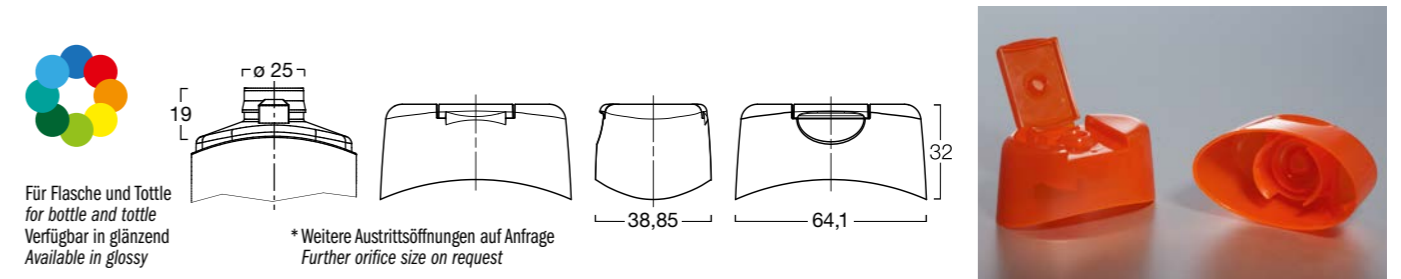

Artikel-Nr. article no.	Material material	Anbringungsart fixing type	Gewindegröße thread size	Austrittsöffnung orifice size	Dichtung seal	Originalitätsverschluss tamper evidence	Kindersicherung child resistance	Entgasung venting device
13009..1*	PP	Prellversion push on version	-	6 mm	Konus cone	-	-	-

KLAPPSCHARNIER-PRELLVERSCHLÜSSE // FLIP-TOP PUSH ON CAPS

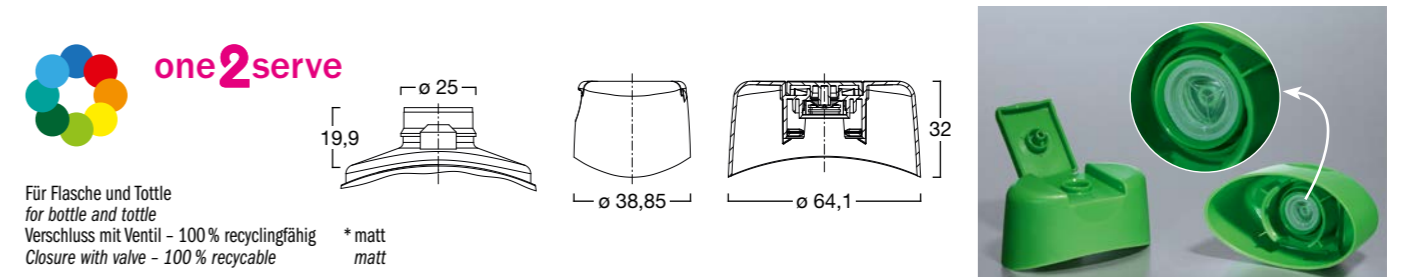

Artikel-Nr. article no.	Material material	Anbringungsart fixing type	Gewindegröße thread size	Austrittsöffnung orifice size	Dichtung seal	Originalitätsverschluss tamper evidence	Kindersicherung child resistance	Entgasung venting device
35604..1*	PP	Prellversion push on version	-	-	Konus cone	-	-	-

KLAPPSCHARNIER-PRELLVERSCHLÜSSE // FLIP-TOP PUSH ON CAPS



One2close®

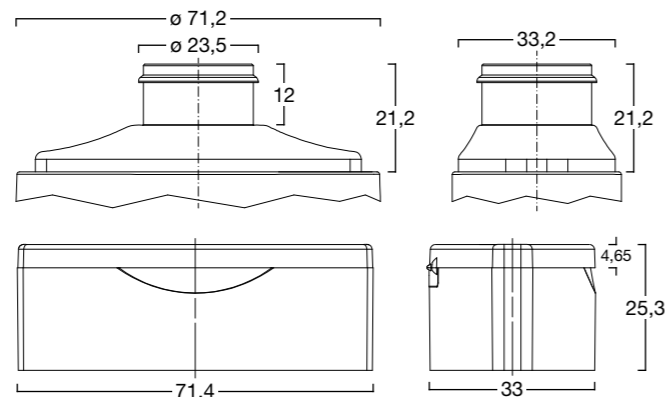

Artikel-Nr. article no.	Material material	Anbringungsart fixing type	Gewindegröße thread size	Austrittsöffnung orifice size	Dichtung seal	Originalitätsverschluss tamper evidence	Kindersicherung child resistance	Entgasung venting device
12851..1	PP	Prellversion push on version	-	4,2 mm	Konus cone	-	-	-
12851..2	PP	Prellversion push on version	-	3 mm	Konus cone	-	-	-

KLAPPSCHARNIER-PRELLVERSCHLÜSSE // FLIP-TOP PUSH ON CAPS



One2close® mini

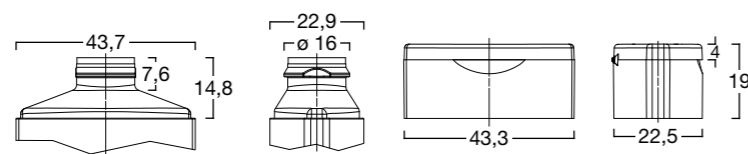

Artikel-Nr. article no.	Material material	Anbringungsart fixing type	Gewindegröße thread size	Austrittsöffnung orifice size	Dichtung seal	Originalitätsverschluss tamper evidence	Kindersicherung child resistance	Entgasung venting device
12903..1	PP	Prellversion push on version	-	3 mm	Konus cone	-	-	-

KIPPHEBEL-SCHRAUBVERSCHLÜSSE // TURRET SCREW CAPS

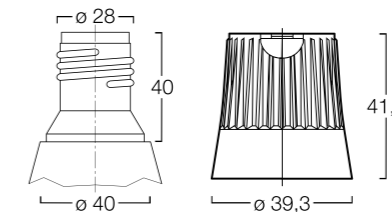

Artikel-Nr. article no.	Material Verschluss material closure	Material Kipphebel material turret	Anbringungsart fixing type	Gewindegröße thread size	Austrittsöffnung orifice size	Dichtung seal	Originalitätsverschluss tamper evidence	Kindersicherung child resistance	Entgasung venting device
35203..1	PP	PP	Schraubversion screw version	28 mm	4 mm	Konus cone	-	-	-

KIPPHEBEL-SCHRAUBVERSCHLÜSSE // TURRET SCREW CAPS

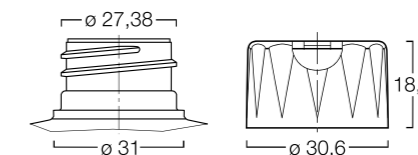

Artikel-Nr. article no.	Material Verschluss material closure	Material Kipphebel material turret	Anbringungsart fixing type	Gewindegröße thread size	Austrittsöffnung orifice size	Dichtung seal	Originalitätsverschluss tamper evidence	Kindersicherung child resistance	Entgasung venting device
35208..1	PP	PP	Schraubversion screw version	28 / 410	4 mm	Konus cone	-	-	-

KIPPHEBEL-SCHRAUBVERSCHLÜSSE // TURRET SCREW CAPS

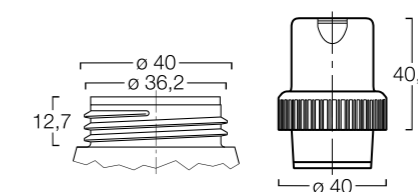

Artikel-Nr. article no.	Material Verschluss material closure	Material Kipphebel material turret	Anbringungsart fixing type	Gewindegröße thread size	Austrittsöffnung orifice size	Dichtung seal	Originalitätsverschluss tamper evidence	Kindersicherung child resistance	Entgasung venting device
52127..1	PP	PP	Schraubversion screw version	36 mm	4 mm	Konus cone	-	-	-

VERSCHLÜSSE FÜR TUBEN // TUBE CLOSURES



Ø 38 mm mit konturbündigem Schamier.
Für 40er-Tube
Ø 38 mm hinge with a flush profile.
For tube with diameter 40

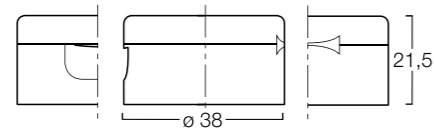

Artikel-Nr. article no.	Material material	Anbringungsart fixing type	Gewindegröße thread size	Ø Austrittsöffnung Ø orifice size	Dichtung seal	Oberfläche surface	Drehrichtung direction for turning
11757..1	PP	Schraubversion screw version	M 15 x 1,5	4 mm	Konus cone	glatt polished	-
11757..2	PP	Schraubversion screw version	M 15 x 1,5	5 mm	Konus cone	glatt polished	-
11757..3	PP	Schraubversion screw version	M 15 x 1,5	3 mm	Konus cone	glatt polished	-

VERSCHLÜSSE FÜR TUBEN // TUBE CLOSURES



Ø 48 mm. Für 50er-Tuben
Ø 48 mm. For tube with diameter 50

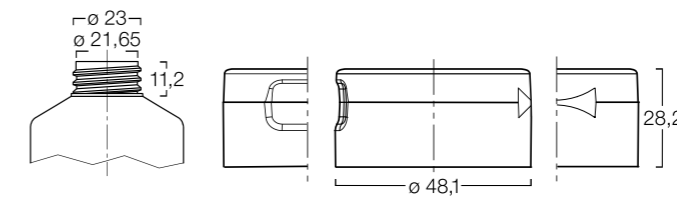

Artikel-Nr. article no.	Material material	Anbringungsart fixing type	Gewindegröße thread size	Ø Austrittsöffnung Ø orifice size	Dichtung seal	Oberfläche surface	Drehrichtung direction for turning
13033..1	PP	Schraubversion screw version	M 22 x 3	4 mm	Konus cone	glatt polished	-
13033..2	PP	Schraubversion screw version	M 22 x 3	3 mm	Konus cone	glatt polished	-
13033..3	PP	Schraubversion screw version	M 22 x 3	6 mm	Konus cone	glatt polished	-

VERSCHLÜSSE FÜR TUBEN // TUBE CLOSURES

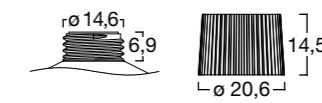

Artikel-Nr. article no.	Material material	Anbringungsart fixing type	Gewindegröße thread size	Ø Austrittsöffnung Ø orifice size	Dichtung seal	Oberfläche surface	Drehrichtung direction for turning
12518..1	PE	Schraubversion screw version	M 15 x 1,5	-	Konus cone	geriffelt ribbed	-

SCHWAMMAUFTRÄGER FÜR PASTÖSE FÜLLGÜTER // SPONGE APPLICATORS FOR VISCOUS FILLINGS

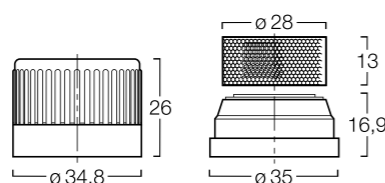

Für 35er-Tube
for tube with diameter 35

Artikel-Nr. article no.	Material Oberteil material upper part	Material Unterteil material base	Gewindegröße thread size	Drehrichtung thread direction	Austrittsöffnung orifice size	Dichtung seal
51024.A	PP	PE	M 11 x 1,25	rechts right	Schwamm mit mittigem Loch sponge with hole in the middle	Konus cone
51024.B	PP	PE	M 15 x 1,5	rechts right	Schwamm mit mittigem Loch sponge with hole in the middle	Konus cone
51024.C	PP	PE	M 11 x 1,5	links left	Schwamm mit mittigem Loch sponge with hole in the middle	Konus cone

SCHWAMMAUFTRÄGER FÜR PASTÖSE FÜLLGÜTER // SPONGE APPLICATORS FOR VISCOUS FILLINGS

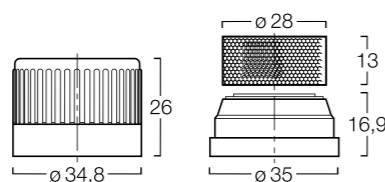

Für Flasche
for bottle

Artikel-Nr. article no.	Material Oberteil material upper part	Material Unterteil material base	Gewindegröße thread size	Drehrichtung thread direction	Austrittsöffnung orifice size	Dichtung seal
51024..D	PP	PE	26,7 mm	-	Schwamm mit mittigem Loch sponge with hole in the middle	Konus cone
51024..E*	PP	PE	26,7 mm	-	Schwamm mit mittigem Loch sponge with hole in the middle	Konus cone

*Verfügbar als Prellversion
*Available as push-on version

SCHWAMMAUFTRÄGER FÜR PASTÖSE FÜLLGÜTER // SPONGE APPLICATORS FOR VISCOUS FILLINGS



Handaufträger
hand applicator

Ausführliche Artikelbeschreibung siehe Seite 41
Details about this article see page 41

Verpackung Kit A42
Packaging Kit A42

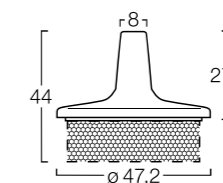

Artikel-Nr. article no.	Version	Material Basis material basis	Artikelbezeichnung article description	Ventil Standard valve standard	Ventil kurz valve short	Ø Austrittsöffnung Ø orifice size	Schaumstofftyp sponge type
51021..A	A42	PP	Handapplikator hand applicator	-	-	-	V-65
52058..A	A42	PP	Deckel lid	-	-	-	-
76005..A	A42	Glas glass	Tiegel jar	-	-	-	-
81011..A	A42	PP	Kit kit	-	-	-	V-65

SCHWAMMAUFTRÄGER FÜR FLÜSSIGE FÜLLGÜTER // SPONGE APPLICATORS FOR LIQUID FILLINGS

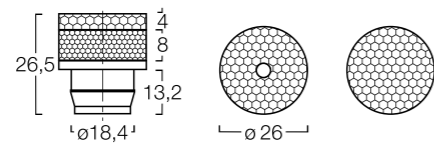

Schwammafträger, rund
round sponge applicator

Artikel-Nr. article no.	Version version	Material Basis material basis	Material Ventil material valve	Ventil Standard valve standard	Ventil kurz valve short	Ø Austrittsöffnung Ø orifice size	Schaumstofftyp sponge type
51015..G	A1	LDPE	LDPE	■	-	Schwamm mit mittigem Loch sponge with hole in the middle	V-8 + PPI-20
51015..H	A1	LDPE	LDPE	-	■	Schwamm ohne mittiges Loch sponge without hole in the middle	V-8 + PPI-20

SCHWAMMAUFTRÄGER FÜR FLÜSSIGE FÜLLGÜTER // SPONGE APPLICATORS FOR LIQUID FILLINGS

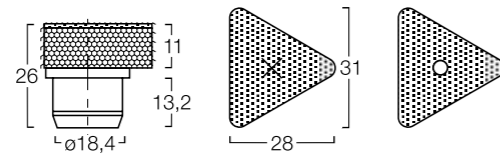

Schwammafträger, dreieckig
triangular sponge applicator

Artikel-Nr. article no.	Version version	Material Basis material basis	Material Ventil material valve	Ventil Standard valve standard	Ventil kurz valve short	Ø Austrittsöffnung Ø orifice size	Schaumstofftyp sponge type
71011..A	A4	LDPE	LDPE	■	-	Schwamm mit Kreuzschlitz, mittig sponge with cross slot in the middle	V-65
71011..B	A4	LDPE	LDPE	■	-	Schwamm mit mittigem Loch sponge with hole in the middle	V-8

SCHWAMMAUFTRÄGER FÜR FLÜSSIGE FÜLLGÜTER // SPONGE APPLICATORS FOR LIQUID FILLINGS



Schwammafträger, rund
round sponge applicator

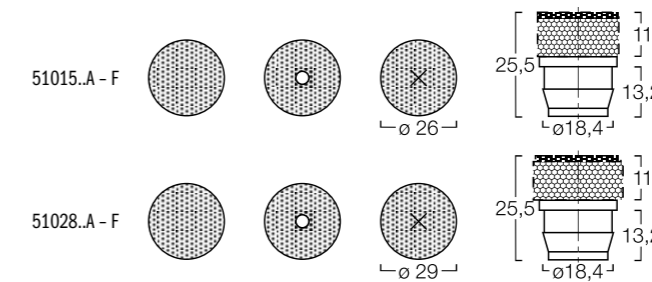

Artikel-Nr. article no.	Version version	Material Basis material basis	Material Ventil material valve	Ventil Standard valve standard	Ventil kurz valve short	Ø Austrittsöffnung Ø orifice size	Schaumstofftyp sponge type
51015..A	A1	LDPE	LDPE	■	-	Schwamm mit Kreuzschlitz, mittig sponge with cross slot in the middle	V-65
51015..B	A1	LDPE	LDPE	■	-	Schwamm mit mittigem Loch sponge with hole in the middle	V-65
51015..C	A1	LDPE	LDPE	-	■	Schwamm ohne mittiges Loch sponge without hole in the middle	V-65
51015..D	A1	LDPE	LDPE	■	-	Schwamm mit Kreuzschlitz, mittig sponge with cross slot in the middle	V-8
51015..E	A1	LDPE	LDPE	■	-	Schwamm mit mittigem Loch sponge with hole in the middle	V-8
51015..F	A1	LDPE	LDPE	-	■	Schwamm ohne mittiges Loch sponge without hole in the middle	V-8

TECHNISCHE EIGENSCHAFTEN DER SCHWÄMME „PUR“ // TECHNICAL CHARACTERISTICS OF "PUR" MENSHEN SPONGES

Schaumstofftyp sponge type	Rohdichte density DIN 53 420	Stauchhärte compr. resist. DIN 53 577	Zugfestigkeit traction resist. DIN 53 571	Bruchdehnung elasticity limit DIN 53 571	Resid. Verform. resid. deform. DIN 53 572	Aussehen appearance	Farbe color
V-8	45 kg/m ³	15 kPa	450 kPa	380 %	11 %	fein fine	Weiß white
D-55 (V-55)	55 kg/m ³	5,5 kPa	> 200 kPa	> 250 %	> 5 %	-	-
PE closed cell (BC)	60 kg/m ³	80 kPa	0,69 kPa	140 %	-	-	-
V-65	45 kg/m ³	11 kPa	410 kPa	390 %	9 %	fein fine	Weiß white
PPI-20	20 - 24 kg/m ³	3 - 5 kPa	< 80 kPa	< 100 %	5 %	grob coarse	Blau blue
Polyester D-25	25 kg/m ³	3,7 - 4,7 kPa	> 160 kPa	> 120 %	> 10 %	fein fine	Weiß-Grau white-grey

BEI BESTELLUNG BITTE ANGEBEN // IN CASE OF ORDER PLEASE STATE

Wenn nichts Gegenteiliges erwähnt ist, werden alle Schwammaufträger mit Flock geliefert.
Alle Schwammaufträger sind auch ohne Flock lieferbar.

*If not otherwise mentioned, all applicators are supplied flocked.
All Sponge Applicators are deliverable as well without flock.*

OHNE FLOCK // WITHOUT FLOCK

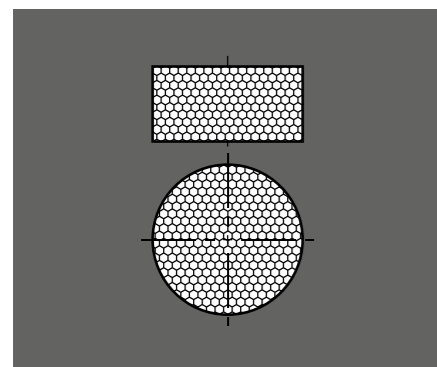

MIT FLOCK // WITH FLOCK

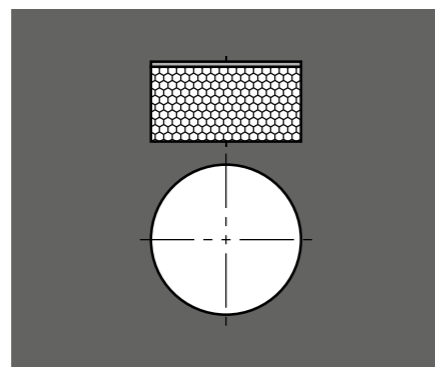

ZWEISCHICHTIG // DOUBLE LAYER

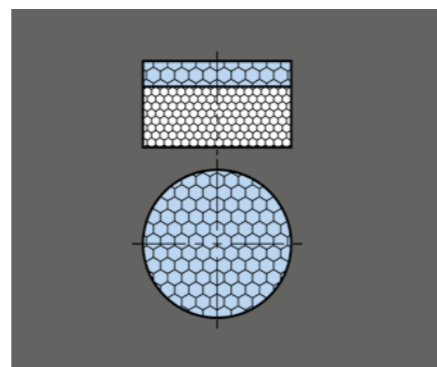

DOSIER-SCHWAMMAUFTRÄGER PAD // DOSING APPLICATOR PAD

Produktkomponenten:

- 15-ml-Flasche (Artikel-Nr. 76002)
- Dosierpumpe (0,075 ml) (Artikel-Nr. 74001)
- Schwammaufträger (Artikel-Nr. 51008)
- transparente Kappe (Artikel-Nr. 52002)

Product Components:

- 15 ml bottle (article no. 76002)
- dosing pump (dosage 0,075 ml) (article no. 74001)
- sponge applicator (article no. 51008)
- transparent cap (article no. 52002)

Anwendungsbereiche:

- Optik
- Informatik
- Audio/Video
- Dermatologie
- Pharma
- Veterinärmedizin
- Kosmetik
- Malerei

Applications:

- optics
- informatics
- audio-video
- dermatology
- pharmacy
- animal care
- cosmetics
- painting



SCHWAMMAUFTRÄGER PLC // SPONGE APPLICATOR PLC

Produktkomponenten:

- 100-ml-Flasche (Artikel-Nr. 76001)
- 50-ml-Flasche (Artikel-Nr. 76017)
- Schwammaufträger (Artikel-Nr. 51015)
- Kappe (Artikel-Nr. 52001)

Product Components:

- 100 ml bottle (article no. 76001)
- 50 ml bottle (article no. 76017)
- sponge applicator (article no. 51015)
- cap (article no. 52001)

Anwendungsbereiche:

- Schuhpflege
- Färbungen
- Leime
- Landwirtschaft
- Haushalt
- Wachse
- Veterinärmedizin

Applications:

- shoe polisher
- coloring
- glue
- agriculture
- household
- wax
- animal care



Flasche lieferbar in Schwarz oder Weiß. Kappe lieferbar in Schwarz, Weiß, Blau, Braun oder Transparent.

Bottle available in black or white. Cap available in black, white, blue, brown or transparent.

VERPACKUNG KIT A42 // PACKAGING KIT A42

Produktkomponenten:

- Glastiegel 50 cc
- Kappe mit Schwammhalterung und innenliegender Aluminium-Einlage, Hand-Schwamm-aufträger A42

Product Components:

- glass jar 50 cc
- cap with holder for applicator and internal aluminium liner, hand applicator A42

Anwendungsbereiche:

- Lederpflege
- Skiwachs
- Schuhpflege

Applications:

- leather care
- ski waxing
- shoe polish



in PCR Material verfügbar

available in PCR material

VERSCHLUSSKAPPE // CAP

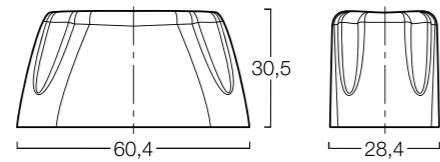

Passend zu Spritzer Art.-Nr. 12160..1
to combine with plug article no. 12160..1

Artikel-Nr. article no.	Material Verschluss material closure	Anbringungsart fixing type	Gewindegröße thread size	Dosiervolumen dosage volume	Dichtung seal	Kindersicherung child resistance	Entgasung venting device
12159..1	PP	Prellversion push on version	-	-	Dorn spigot	-	-

SPRITZER // PLUG

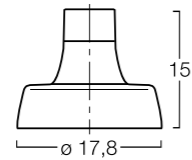

Spritzer, nicht montiert, passend zu Verschluss
Art.-Nr. 12159..1
plug, unassembled, to combine with cap article
no. 12159..1

Artikel-Nr. article no.	Material Spritzer material plug	Anbringungsart fixing type	Gewindegröße thread size	Ø Austrittsöffnung Ø orifice size	Dichtung seal	Kindersicherung child resistance	Entgasung venting device
12160..1	PE	Prellversion push on version	-	4 mm	Konus cone	-	-



2

Weldspouts für flexible Verpackungen Weldspouts for flexible packaging

Vor Ort für Sie.

Starke globale Präsenz zur Lieferung lokaler Lösungen. Angebot einer umfassenden Auswahl an Standard-Weldspouts und kundenspezifischen Weldspout-Lösungen für eine Vielfalt an Produktanwendungen, sowohl für die Befüllung durch das Einschweißsteil als auch durch die Kopfnahm des Beutels.

Unabhängig.

Intensive Zusammenarbeit entlang der Wertschöpfungskette zur Lieferung der optimalen individuellen Lösung. Entwicklung von kompletten Verpackungslösungen sowie Lieferung von marktgerechten Innovationen.

Expertise.

Ihnen steht ein breit aufgestelltes Experten-Team zur Umsetzung technischer und wirtschaftlicher Marktanforderungen zur Verfügung. Lieferung von Produkten auf höchstem Qualitätsniveau, die strengen Funktions- und Sicherheitsstandards entsprechen.

MENSHEN.

Ihr Partner in der Welt der Weldspouts.

Local.

Leveraging our global presence to deliver local solutions. Offering a comprehensive range of standard and customized weldspouts for a variety of product applications, either filled through the spout or through the pouch.

Independent.

Collaborating with partners across the supply chain to deliver optimal solutions. Developing total package solutions and delivering commercially-ready innovations.

Expertise.

A multi-disciplinary team, dedicated to meet technical and commercial market needs, is on-hand to support you. Delivering high-quality products that meet stringent functionality & safety requirements.

MENSHEN.

Your partner in the world of weldspouts.

FÜLLUNG DURCH DEN BEUTEL // FILLING THROUGH POUCH

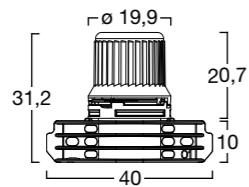

Light Weight Spout-A

Artikel-Nr. article no.	Produktionsstandort production site	Material ESWT material spout	Material Verschluss material cap	Ø Austrittsöffnung Ø orifice size	Originalitätsverschluss tamper evidence
38575.4	DE	PE	PE	11 mm	■
38575.2	CN	PE	PE	11 mm	■

FÜLLUNG DURCH DEN BEUTEL // FILLING THROUGH POUCH

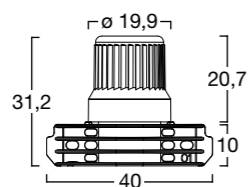

Light Weight Spout-A

Artikel-Nr. article no.	Produktionsstandort production site	Material ESWT material spout	Material Verschluss material cap	Ø Austrittsöffnung Ø orifice size	Originalitätsverschluss tamper evidence
38583.2	DE	PE	PE	11 mm	-

FÜLLUNG DURCH DEN BEUTEL // FILLING THROUGH POUCH

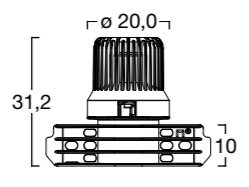

Hemera

Artikel-Nr. article no.	Produktionsstandort production site	Material ESWT material spout	Material Verschluss material cap	Ø Austrittsöffnung Ø orifice size	Originalitätsverschluss tamper evidence
38586.1	DE	PE	PE	11 mm	■
38587.1	DE	PP	PP	11 mm	■
38593.1	DE	PE low melting	PE	11 mm	■
38594.1	DE	PP low melting	PP	11 mm	■

FÜLLUNG DURCH DEN BEUTEL // FILLING THROUGH POUCH

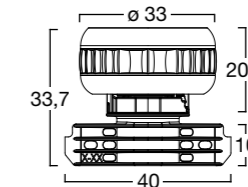

Choke Safe Cap-A Trunk Wheel

Artikel-Nr. article no.	Produktionsstandort production site	Material ESWT material spout	Material Verschluss material cap	Ø Austrittsöffnung Ø orifice size	Originalitätsverschluss tamper evidence
55004.1	ES	PE/PP	PP	9,5 mm	■
638514.1	US	PE	PP	9,5 mm	■
638514.2	US	PP	PP	9,5 mm	■

FÜLLUNG DURCH DEN BEUTEL // FILLING THROUGH POUCH

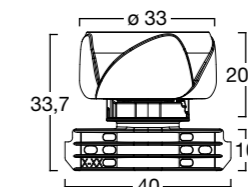

Choke Safe Cap-A Twisted Leaves

Artikel-Nr. article no.	Produktionsstandort production site	Material ESWT material spout	Material Verschluss material cap	Ø Austrittsöffnung Ø orifice size	Originalitätsverschluss tamper evidence
38521.1	DE	PE/PP	PP	9,5 mm	■

FÜLLUNG DURCH DEN BEUTEL // FILLING THROUGH POUCH

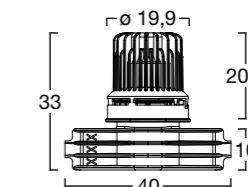

Fruity

Artikel-Nr. article no.	Produktionsstandort production site	Material ESWT material spout	Material Verschluss material cap	Ø Austrittsöffnung Ø orifice size	Originalitätsverschluss tamper evidence
38561.9	DE	PE	PE	8,5 mm	■

FÜLLUNG DURCH DEN BEUTEL // FILLING THROUGH POUCH

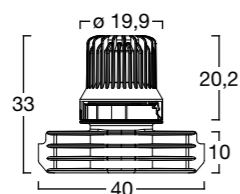

Apple Safe

Artikel-Nr. article no.	Produktionsstandort production site	Material ESWT material spout	Material Verschluss material cap	Ø Austrittsöffnung Ø orifice size	Originalitätsverschluss tamper evidence
38569..1	DE	PE	PE	8,5 mm	■

FÜLLUNG DURCH DEN BEUTEL // FILLING THROUGH POUCH

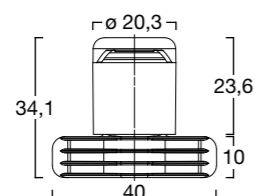

Artikel-Nr. article no.	Produktionsstandort production site	Material ESWT material spout	Material Verschluss material cap	Ø Austrittsöffnung Ø orifice size	Originalitätsverschluss tamper evidence
38525..1	DE	PE	PP	4 mm	-

FÜLLUNG DURCH DEN BEUTEL // FILLING THROUGH POUCH

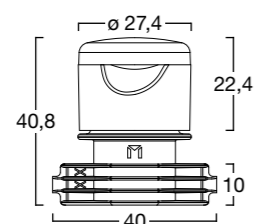

Artikel-Nr. article no.	Produktionsstandort production site	Material ESWT material spout	Material Verschluss material cap	Ø Austrittsöffnung Ø orifice size	Originalitätsverschluss tamper evidence
38573..1	DE	PE	PP	1,5; 3; 4,4 mm	-

FÜLLUNG DURCH DEN BEUTEL // FILLING THROUGH POUCH

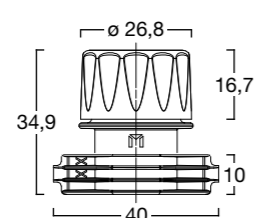

Artikel-Nr. article no.	Produktionsstandort production site	Material ESWT material spout	Material Verschluss material cap	Ø Austrittsöffnung Ø orifice size	Originalitätsverschluss tamper evidence
38556..1	DE	PE	PP	19 mm	-

FÜLLUNG DURCH DEN BEUTEL // FILLING THROUGH POUCH

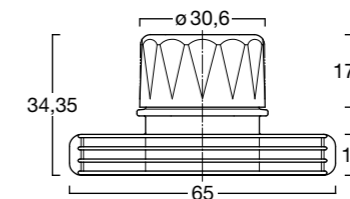

Artikel-Nr. article no.	Produktionsstandort production site	Material ESWT material spout	Material Verschluss material cap	Ø Austrittsöffnung Ø orifice size	Originalitätsverschluss tamper evidence
38515..1	DE	PE	PP	21 mm	-

FÜLLUNG DURCH DEN BEUTEL // FILLING THROUGH POUCH

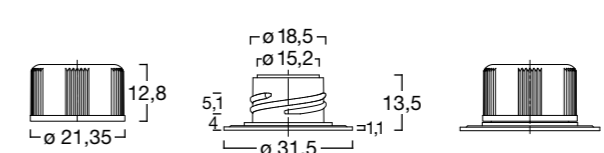

Front Valve

Artikel-Nr. article no.	Produktionsstandort production site	Material ESWT material spout	Material Verschluss material cap	Ø Austrittsöffnung Ø orifice size	Originalitätsverschluss tamper evidence
601510	MX	PE	PE	11 mm	■

FÜLLUNG DURCH DEN BEUTEL // FILLING THROUGH POUCH

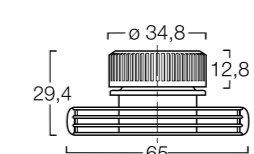

Mit und ohne ALU Liner erhältlich
available with and without ALU Liner

Artikel-Nr. article no.	Produktionsstandort production site	Material ESWT material spout	Material Verschluss material cap	Ø Austrittsöffnung Ø orifice size	Originalitätsverschluss tamper evidence
38506..1	DE	PE	PP	25 mm	-
38506..2	DE	PE/PP	PP	25 mm	■

FÜLLUNG DURCH DEN BEUTEL // FILLING THROUGH POUCH

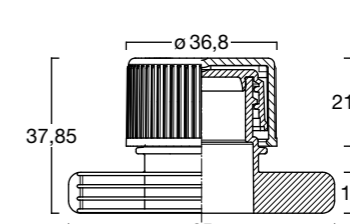

Geeignet für kindergesicherte Verpackungen
suitable for child resistant packaging

Artikel-Nr. article no.	Produktionsstandort production site	Material ESWT material spout	Material Verschluss material cap	Ø Austrittsöffnung Ø orifice size	Originalitätsverschluss tamper evidence
38555..1	DE	PE	PP	21 mm	-

FÜLLUNG DURCH DEN BEUTEL // FILLING THROUGH POUCH

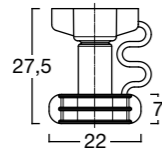

Mit wiederverschließbarer Abbrechkappe
with reclosable break-off cap

Artikel-Nr. article no.	Produktionsstandort production site	Material ESWT material spout	Material Verschluss material cap	Ø Austrittsöffnung Ø orifice size	Originalitätsverschluss tamper evidence
12994..1	DE	PE	-	6,5 mm	■

FÜLLUNG DURCH DEN WELDSPOUT // FILLING THROUGH WELDSPOUT

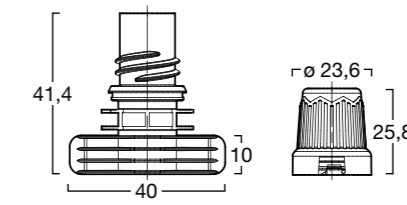

Smart Break

Artikel-Nr. article no.	Produktionsstandort production site	Material ESWT material spout	Material Verschluss material cap	Ø Austrittsöffnung Ø orifice size	Originalitätsverschluss tamper evidence
WELDSPOUT // WELDSPOUT					
12463..1	DE	PE	-	12,5 mm	-
VERSCHLUSS // CAP					
12464..1	DE	-	PP	-	■

FÜLLUNG DURCH DEN WELDSPOUT // FILLING THROUGH WELDSPOUT

Vormontiert
preassembled

Mit Originalität für aseptische Abfüllung
with tamper evidence for aseptic filling

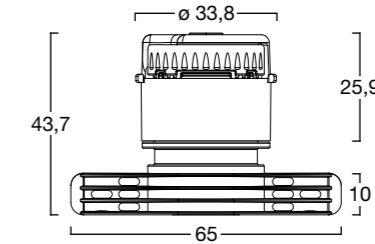

Artikel-Nr. article no.	Produktionsstandort production site	Material ESWT material spout	Material Verschluss material cap	Ø Austrittsöffnung Ø orifice size	Originalitätsverschluss tamper evidence
38585..1	DE	PE	PP	11,6 mm	■

FÜLLUNG DURCH DEN WELD SPOUT // FILLING THROUGH WELD SPOUT

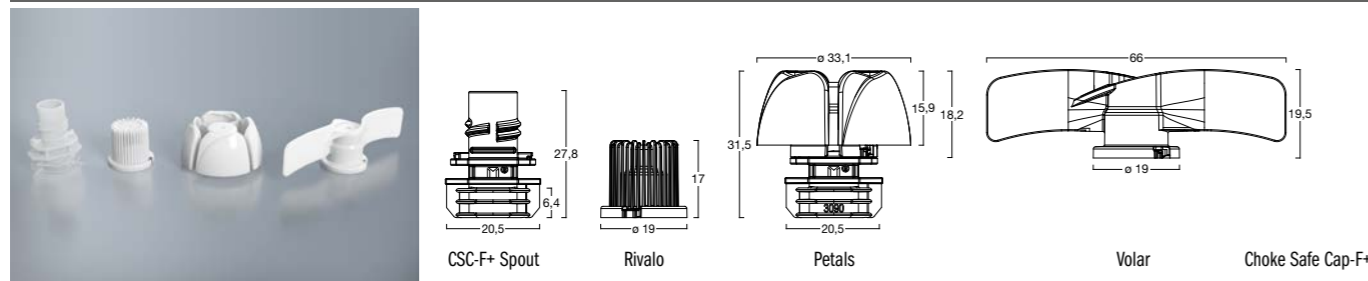

Artikel-Nr. article no.	Produktionsstandort production site	Material ESWT material spout	Material Verschluss material cap	Ø Austrittsöffnung Ø orifice size	Originalitätsverschluss tamper evidence
WELD SPOUT // WELD SPOUT – CSC-F+ SPOUT					
13090..1	DE	PE/PP	-	8,5 mm	-
VERSCHLUSS // CAP – RIVALO					
13091..1	DE	-	PE/PP	-	■
VERSCHLUSSSICHERER VERSCHLUSS // CHOKE SAFE CAP – PETALS					
55008	ES	-	PE/PP	-	■
VERSCHLUSSSICHERER VERSCHLUSS // CHOKE SAFE CAP – VOLAR					
13092..1	DE	-	PE/PP	-	■

FÜLLUNG DURCH DEN WELD SPOUT // FILLING THROUGH WELD SPOUT

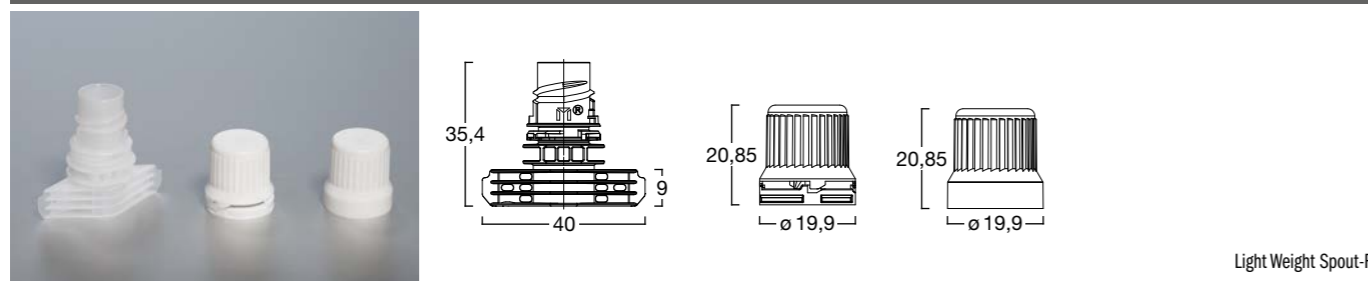

Artikel-Nr. article no.	Produktionsstandort production site	Material ESWT material spout	Material Verschluss material cap	Ø Austrittsöffnung Ø orifice size	Originalitätsverschluss tamper evidence
WELD SPOUT // WELD SPOUT					
12813..1	DE	PE	-	11 mm	-
VERSCHLUSS MIT ORIGINALITÄT // CAP WITH TAMPER EVIDENCE					
12982..1	DE	-	PE	-	■
VERSCHLUSS // CAP					
12983..1	DE	-	PE	-	-

FÜLLUNG DURCH DEN BEUTEL UND DEN WELD SPOUT // FILLING THROUGH POUCH AND WELD SPOUT

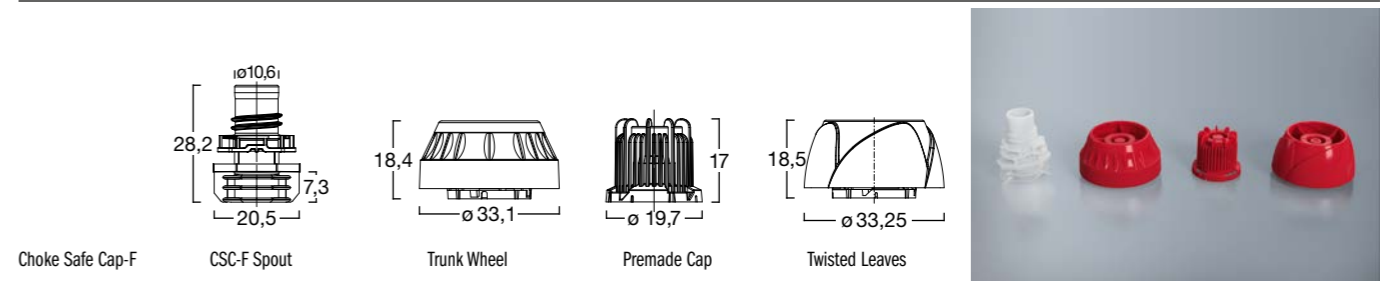

Artikel-Nr. article no.	Produktionsstandort production site	Material ESWT material spout	Material Verschluss material cap	Ø Austrittsöffnung Ø orifice size	Originalitätsverschluss tamper evidence
WELD SPOUT // WELD SPOUT – CSC-F SPOUT					
612959..2	US	PE	-	8,5 mm	-
612959..5	US	PP	-	8,5 mm	-
WSF07500 1000123	MX	PP/PE	-	8,5 mm	-
46013019017	RU	PE	-	8,5 mm	-
VERSCHLUSSSICHERER VERSCHLUSS // CHOKE SAFE CAP – TRUNK WHEEL					
SF07500 1000XXX	MX	-	PP/PE	-	■
VERSCHLUSS // CAP – Premade Cap					
55006..1	ES	-	PP	-	■
VERSCHLUSSSICHERER VERSCHLUSS // CHOKE SAFE CAP – TWISTED LEAVES					
WSF07500 1000XXTL	MX	-	PP/PE	-	■
460130741	RU	-	PP	-	■

FÜLLUNG DURCH DEN BEUTEL UND DEN WELD SPOUT // FILLING THROUGH POUCH AND WELD SPOUT

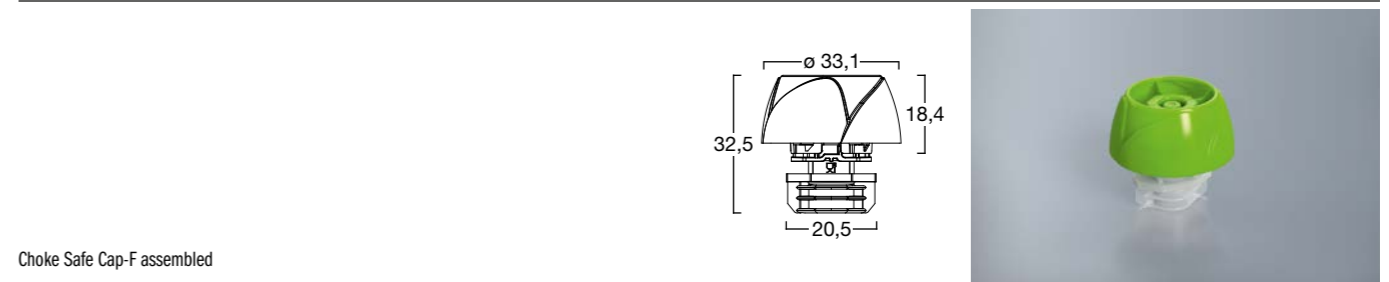

Artikel-Nr. article no.	Produktionsstandort production site	Material ESWT material spout	Material Verschluss material cap	Ø Austrittsöffnung Ø orifice size	Originalitätsverschluss tamper evidence
46039253008	RU	PE	PP	8,5 mm	■

FÜLLUNG DURCH DEN BEUTEL UND DEN WELD SPOUT // FILLING THROUGH POUCH AND WELD SPOUT

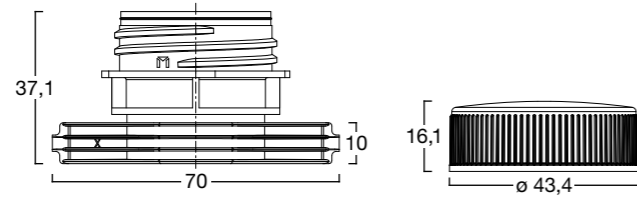

Artikel-Nr. article no.	Produktionsstandort production site	Material ESWT material spout	Material Verschluss material cap	Ø Austrittsöffnung Ø orifice size	Originalitätsverschluss tamper evidence
WELD SPOUT // WELD SPOUT					
12606..1	DE	PE	-	34 mm	-
VERSCHLUSS // CAP					
12607..1	DE	-	PP	-	-

FÜLLUNG DURCH DEN BEUTEL UND DEN WELD SPOUT // FILLING THROUGH POUCH AND WELD SPOUT

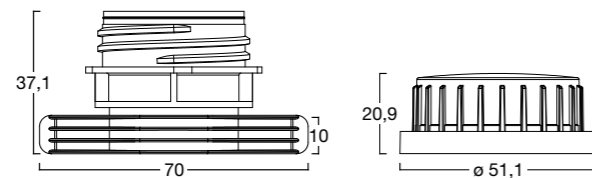

Artikel-Nr. article no.	Produktionsstandort production site	Material ESWT material spout	Material Verschluss material cap	Ø Austrittsöffnung Ø orifice size	Originalitätsverschluss tamper evidence
WELD SPOUT // WELD SPOUT					
611915991	US	PE	-	34 mm	-
VERSCHLUSS // CAP					
611113001	US	-	PP	-	■

FÜLLUNG DURCH DEN BEUTEL UND DEN WELD SPOUT // FILLING THROUGH POUCH AND WELD SPOUT

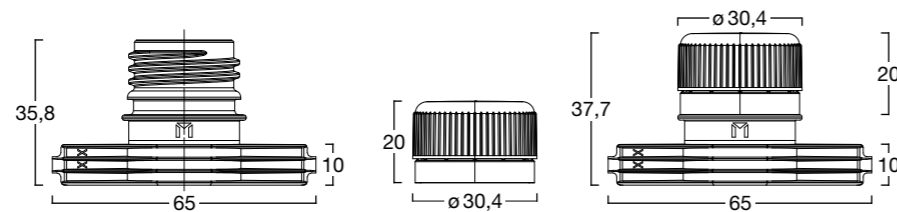

Artikel-Nr. article no.	Produktionsstandort production site	Material ESWT material spout	Material Verschluss material cap	Ø Austrittsöffnung Ø orifice size	Originalitätsverschluss tamper evidence
WELD SPOUT // WELD SPOUT					
12546..7	DE	PE	-	21,5 mm	-
VERSCHLUSS // CAP					
12820..1	DE	-	PE	-	■
13101..1	DE	-	PE	-	-
WELD SPOUT MIT VERSCHLUSS // WELD SPOUT WITH CAP					
38576..1	DE	PE	PE	21,5 mm	■

FÜLLUNG DURCH DEN BEUTEL UND DEN WELD SPOUT // FILLING THROUGH POUCH AND WELD SPOUT

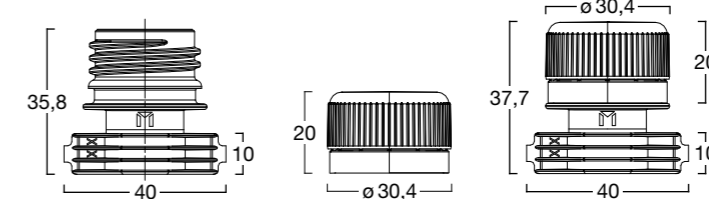

Artikel-Nr. article no.	Produktionsstandort production site	Material ESWT material spout	Material Verschluss material cap	Ø Austrittsöffnung Ø orifice size	Originalitätsverschluss tamper evidence
WELD SPOUT // WELD SPOUT					
12839..1	DE	PE	-	21,5 mm	-
VERSCHLUSS // CAP					
12820..1	DE	-	PE	-	■
13101..1	DE	-	PE	-	-
WELD SPOUT MIT VERSCHLUSS // WELD SPOUT WITH CAP					
38577..1	DE	PE	PE	21,5 mm	■

FÜLLUNG DURCH DEN BEUTEL UND DEN WELD SPOUT // FILLING THROUGH POUCH AND WELD SPOUT

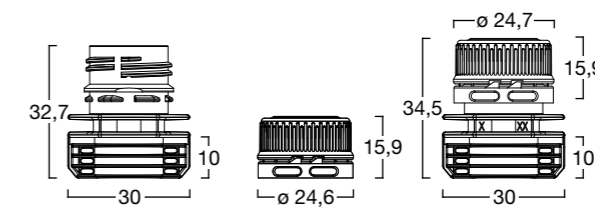

Artikel-Nr. article no.	Produktionsstandort production site	Material ESWT material spout	Material Verschluss material cap	Ø Austrittsöffnung Ø orifice size	Originalitätsverschluss tamper evidence
WELD SPOUT // WELD SPOUT					
13065..1	CN	PE	-	17,2 mm	-
VERSCHLUSS // CAP					
13066..1	CN	-	PP	-	■
WELD SPOUT MIT VERSCHLUSS // WELD SPOUT WITH CAP					
38571..1	CN	PE	PP	17,2 mm	■

Die höchsten Qualitätsstandards.

Zu jeder Zeit. Überall.

The highest quality standards.

Anytime. Anywhere.

▼
MENSHEN – SUSTAINABLE INNOVATIVE PACKAGING.





3

Chemieverschlüsse *Chemical closures*

In der chemischen Industrie hat Sicherheit Priorität. Deshalb setzen wir bei MENSHEN, als Vollsortimenter und führender Anbieter im Bereich der Chemieverschlüsse, auf die umfassenden Branchenkenntnisse und Kompetenzen unserer Mitarbeiter*innen. Unser Anspruch: Chemieverschlüsse von MENSHEN müssen selbst bei Großserien alle Qualitäts- und Sicherheitsstandards bestens erfüllen. Dank ausgereifter Fertigungsprozesse und einer permanenten Qualitätssicherung sowie Fertigungsüberwachung können wir größte Zuverlässigkeit bei unseren Produkten garantieren.

Wir wissen: Jeder Anwendungsbereich hat individuelle Anforderungen. Deshalb können Sie je nach Einsatzgebiet aus verschiedenen Produkteigenschaften und Zusatzfunktionen wählen. Gerne beraten wir Sie über die wichtigsten Eigenschaften und entwickeln bei Bedarf Sonderlösungen, die Ihren Vorstellungen vollständig entsprechen.

Safety is of the utmost importance in the chemicals industry. Therefore, at MENSHEN, we rely on the extensive industry knowledge and expertise of our employees as a full-line supplier and leading provider of chemical closures. Our mission: MENSHEN chemical closures must optimally fulfill all quality and safety standards, even in large-batch production. Thanks to sophisticated manufacturing processes, constant quality assurance, and production monitoring, we can guarantee the highest level of reliability in our products.

We know that each application has its own individual requirements. As a result, you can choose from various product characteristics and additional functions depending on the area of application. We would be happy to discuss the main characteristics with you, and we also develop special solutions on request that fully meet your requirements.

ORIGINALITÄTSVERSCHLÜSSE // TAMPER-EVIDENT CLOSURES

Die Originalitätsverschlüsse von MENSHEN signalisieren Konsumenten*innen das erstmalige Öffnen des Deckels. Besonders für die chemische und pharmazeutische Industrie stellt dieser Verschluss einen unverzichtbaren Sicherheitsfaktor dar. MENSHEN bietet für jede Anforderung die passende Lösung. Als Kunde haben Sie deshalb die Wahl zwischen verschiedenen Originalitätsverschlüssen mit innenliegendem, konturbündigem oder außenstehendem Ring.

MENSHEN tamper-evident closures signal when they have been undone for the first time and are especially designed for consumer protection purposes. This type of closure is an indispensable safety factor for the chemical and pharmaceutical industries. Whether with an internal tamper-evident ring, being flush to the cap diameter, or with an external ring – there is always a suitable solution for every requirement.

ENTGASUNGSVERSCHLÜSSE // CLOSURES WITH VENTING DEVICE

Die Entgasungsverschlüsse von MENSHEN ermöglichen den gesteuerten und dadurch sicheren Austritt von entstandenen Gasen der Füllgüter. Der Druck im Behälter wird konstant gehalten. Gleichzeitig verhindern Entgasungsverschlüsse selbstverständlich auch das Austreten von Flüssigkeiten, und das in bewährter Qualität. Durch jahrelange Forschung und die enge Zusammenarbeit mit unseren Kunden sind MENSHEN Produkte so optimiert, dass wir höchste Sicherheit garantieren können.

Many years of research, planning and cooperation with our customers have made it possible to optimise our products, enabling us to guarantee a high degree of safety. Our closures with venting devices allow the controlled escape of gases produced by the product and thus keep the pressure in the container at a constant level. At the same time, they prevent the liquids from leaking with proven MENSHEN tightness.

KINDERGESICHERTE VERSCHLÜSSE // CHILD RESISTANT CLOSURES

Besonders Chemikalienbehälter müssen im Haushalt hohe Sicherheitsstandards erfüllen, um keine Gefahr darzustellen. Die kindergesicherten Verschlüsse von MENSHEN verfügen über eine Mechanik, die optimal vor unerwünschtem Öffnen schützt. Für Erwachsene stellt die spezielle Sicherung trotzdem kein Hindernis dar. Übrigens: Alle MENSHEN Produkte erfüllen die internationalen Normen für kindergesicherte Verpackungen.

We are all aware of the high safety factor which chemical containers require in the household. Child-resistant closures are fitted with a mechanism which cannot be opened by children. The special safety lock always reliably prevents children from opening them and nevertheless does not pose an obstacle for the elderly. All MENSHEN products meet the international standards for child-resistant packaging – safety is our strength.

ABDICHTUNGSVARIANTEN // SEAL VARIANTS

Besonders bei Chemieverschlüssen ist die absolute Dichtigkeit ein wichtiger Punkt, der Sicherheit gewährleistet. Die Verschlusslösungen von MENSHEN verfügen über unterschiedliche Dichteinlagen, die ein ungewolltes Austreten von Flüssigkeiten oder Gasen verhindern.

Absolute seal tightness is particularly important in the case of chemical closures in order to ensure a high level of safety. MENSHEN closure solutions have a range of seal liners that prevent the unintended leakage of liquids or gases.

- PTFE-Einlage
- PE-Schaumeinlage
- Konusausführung
- PTFE-kaschierte PE-Schaumeinlage
- Induktionseinlage
- Aluminiumbeschichtete Einlage verhindert das Migrieren in die Chemie
- PTFE liner
- PE foam liner
- Cone version
- PTFE/PE foam liner
- Induction liner
- Aluminum-coated liner prevents seeping into chemicals

CHEMIEVERSCHLÜSSE // CHEMICAL CLOSURES

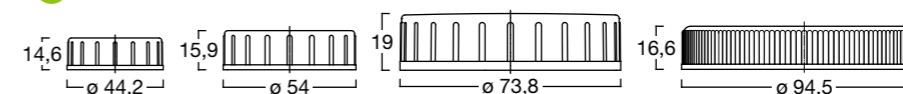

Artikel-Nr. article no.	Material material	Anbringungsart fixing type	Gewindegröße thread size	Dichtung seal	Originalitätsverschluss tamper evidence	Kindersicherung child resistance	Entgasung venting device
20658..1	PE	Schraubversion screw version	40 mm	Einlage liner	-	-	-
20087..1	PE	Schraubversion screw version	50 mm	Einlage liner	-	-	-

CHEMIEVERSCHLÜSSE // CHEMICAL CLOSURES

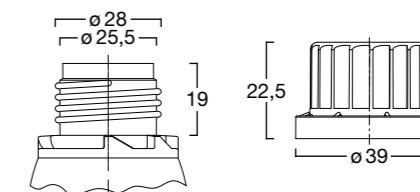

Artikel-Nr. article no.	Material material	Anbringungsart fixing type	Gewindegröße thread size	Dichtung seal	Originalitätsverschluss tamper evidence	Kindersicherung child resistance	Entgasung venting device
11287..1	PP	Schraubversion screw version	28 E	Konus cone	■	-	-
21287..2	PP	Schraubversion screw version	28 E	Einlage liner	■	-	-

CHEMIEVERSCHLÜSSE // CHEMICAL CLOSURES

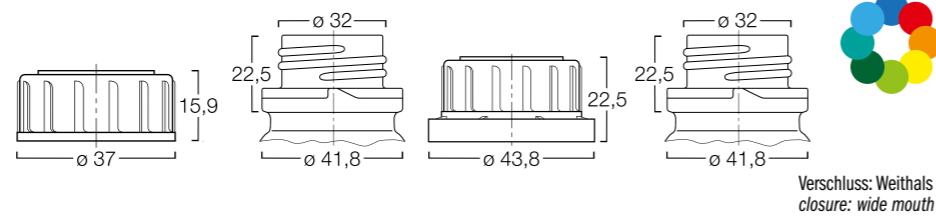

Verschluss: Weithals
closure: wide mouth

Artikel-Nr. article no.	Material material	Anbringungsart fixing type	Gewindegröße thread size	Dichtung seal	Originalitätsverschluss tamper evidence	Kindersicherung child resistance	Entgasung venting device
10678..1	PP	Schraubversion screw version	32 W	Konus cone	■	-	-
20843..1	PP	Schraubversion screw version	32 W	Einlage liner	■	-	-

CHEMIEVERSCHLÜSSE // CHEMICAL CLOSURES

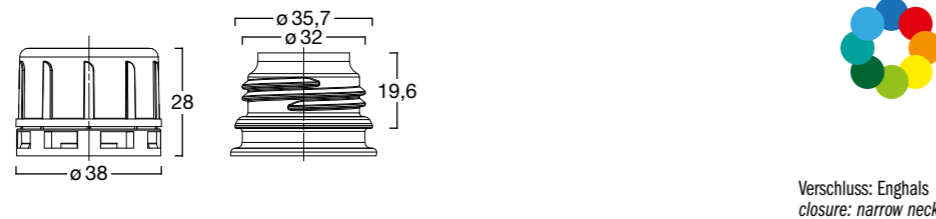

Verschluss: Enghals
closure: narrow neck

Artikel-Nr. article no.	Material material	Anbringungsart fixing type	Gewindegröße thread size	Dichtung seal	Originalitätsverschluss tamper evidence	Kindersicherung child resistance	Entgasung venting device
12544..3	PP	Schraubversion screw version	32 E	Konus cone	■	-	-
22544..1	PP	Schraubversion screw version	32 E	PTFE-Napf PTFE disc	■	-	-
22544..2	PP	Schraubversion screw version	32 E	Einlage liner	■	-	-
22544..5	PP	Schraubversion screw version	32 E	Entgasungseinlage venting liner	■	-	■

CHEMIEVERSCHLÜSSE // CHEMICAL CLOSURES

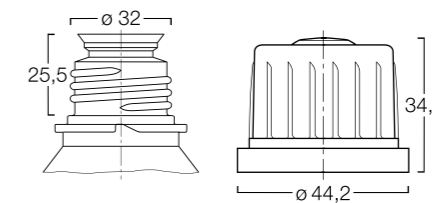

Verschluss: Enghals
closure: narrow neck



Artikel-Nr. article no.	Material material	Anbringungsart fixing type	Gewindegröße thread size	Dichtung seal	Originalitätsverschluss tamper evidence	Kindersicherung child resistance	Entgasung venting device
10677..1	PP	Schraubversion screw version	32 E	Konus cone	■	-	-
20677..1	PP	Schraubversion screw version	32 E	Konus + PTFE-Napf cone + PTFE disc	■	-	-
20842..1	PP	Schraubversion screw version	32 E	Einlage liner	■	-	-
20842..2	PP	Schraubversion screw version	32 E	Entgasungseinlage venting liner	■	-	■

CHEMIEVERSCHLÜSSE // CHEMICAL CLOSURES

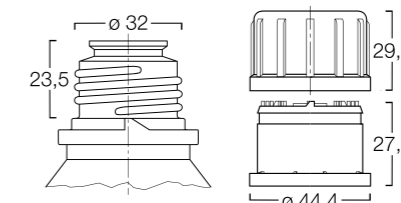

Verschluss: Enghals
closure: narrow neck



Artikel-Nr. article no.	Material Außenteil material outside part	Material Innenteil material inner part	Anbringungsart fixing type	Gewindegröße thread size	Dichtung seal	Originalitätsverschluss tamper evidence	Kindersicherung child resistance	Entgasung venting device
31501..1	PP	PP	Schraubversion screw version	32 E	Konus cone	■	■	-
34501..3	PP	PP	Schraubversion screw version	32 E	Konus cone	■	■	■

CHEMIEVERSCHLÜSSE // CHEMICAL CLOSURES

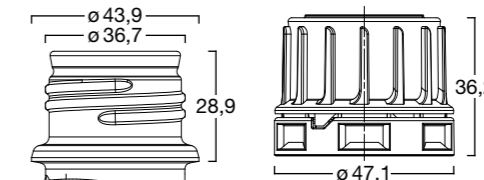

Verschluss: Enghals
closure: narrow neck



Artikel-Nr. article no.	Material Außenteil material outside part	Material Innenteil material inner part	Anbringungsart fixing type	Gewindegröße thread size	Dichtung seal	Originalitätsverschluss tamper evidence	Kindersicherung child resistance	Entgasung venting device
22812..1	PP	-	Schraubversion screw version	38 E	Einlage liner	■	-	-

CHEMIEVERSCHLÜSSE // CHEMICAL CLOSURES

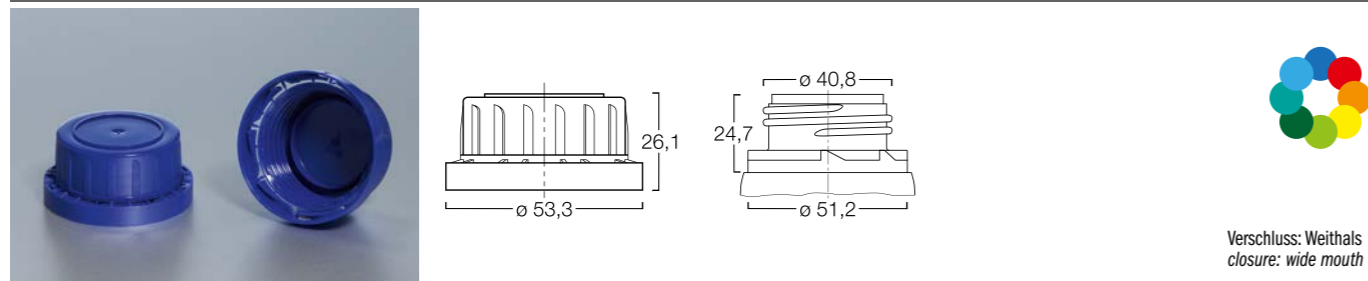

Verschluss: Weithals
closure: wide mouth

Artikel-Nr. article no.	Material material	Anbringungsart fixing type	Gewindegröße thread size	Dichtung seal	Originalitätsverschluss tamper evidence	Kindersicherung child resistance	Entgasung venting device
10713.1	PP	Schraubversion screw version	40 W	Konus cone	■	-	-
20804.1	PP	Schraubversion screw version	40 W	Einlage liner	■	-	-

CHEMIEVERSCHLÜSSE // CHEMICAL CLOSURES

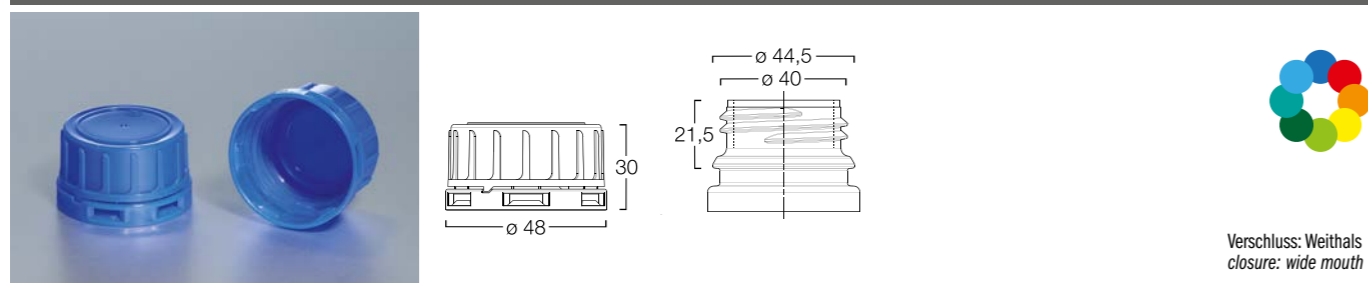

Verschluss: Weithals
closure: wide mouth

Artikel-Nr. article no.	Material material	Anbringungsart fixing type	Gewindegröße thread size	Dichtung seal	Originalitätsverschluss tamper evidence	Kindersicherung child resistance	Entgasung venting device
12745.1	PP	Schraubversion screw version	40 W	Konus cone	■	-	-
22745.1	PP	Schraubversion screw version	40 W	Einlage liner	■	-	-

CHEMIEVERSCHLÜSSE // CHEMICAL CLOSURES

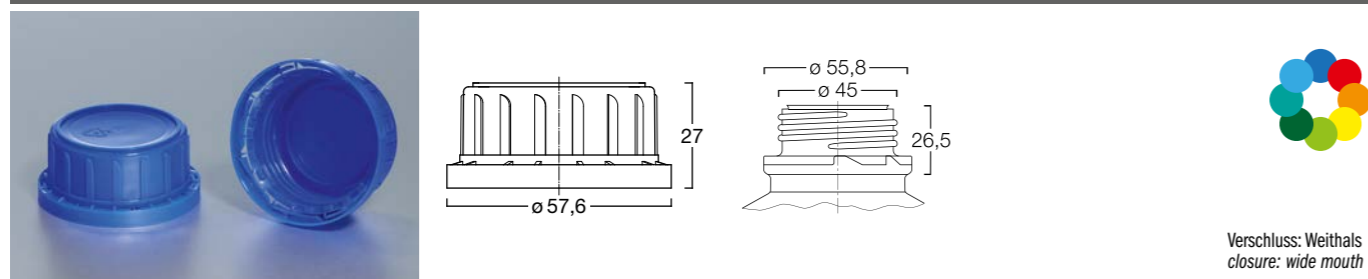

Verschluss: Weithals
closure: wide mouth

Artikel-Nr. article no.	Material material	Anbringungsart fixing type	Gewindegröße thread size	Dichtung seal	Originalitätsverschluss tamper evidence	Kindersicherung child resistance	Entgasung venting device
11663.1	PP	Schraubversion screw version	45 W	Konus cone	■	-	-
20709.1	PP	Schraubversion screw version	45 W	Einlage liner	■	-	-

CHEMIEVERSCHLÜSSE // CHEMICAL CLOSURES

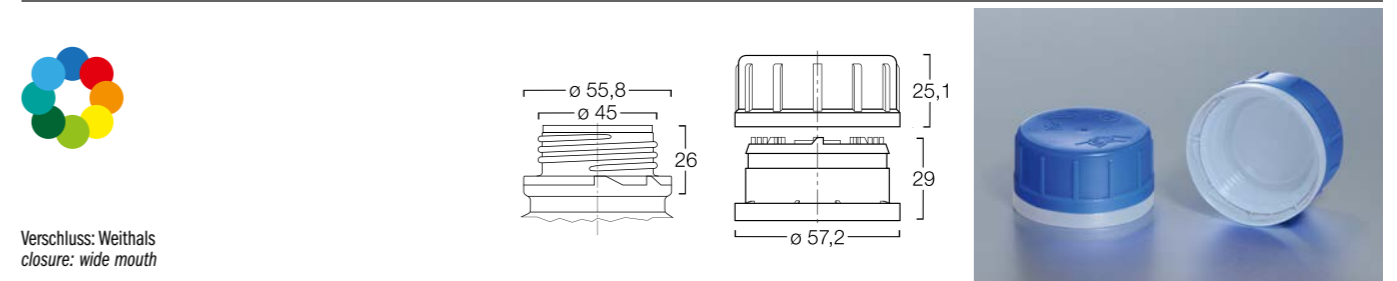

Verschluss: Weithals
closure: wide mouth

Artikel-Nr. article no.	Material Außenteil material outside part	Material Innenteil material inner part	Anbringungsart fixing type	Gewindegröße thread size	Dichtung seal	Originalitätsverschluss tamper evidence	Kindersicherung child resistance	Entgasung venting device
31504.1	PP	PP	Schraubversion screw version	45 W	Konus cone	■	■	-
34502.3	PP	PP	Schraubversion screw version	45 W	Konus cone	■	■	■

CHEMIEVERSCHLÜSSE // CHEMICAL CLOSURES

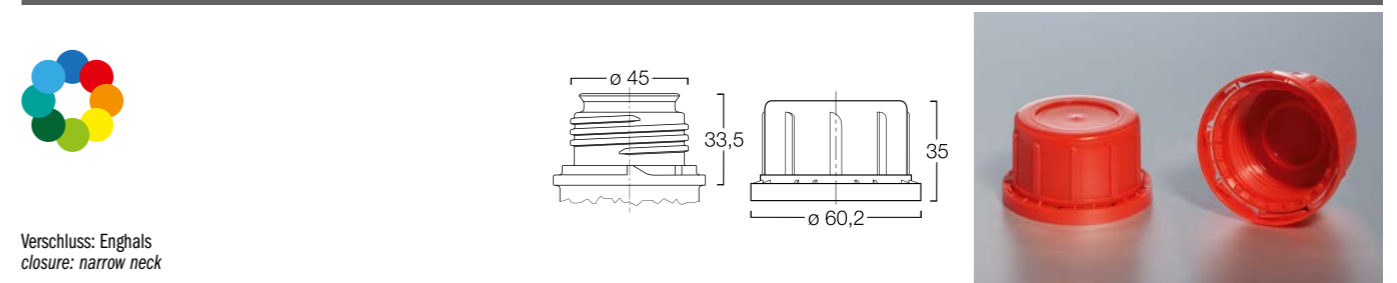

Verschluss: Enghals
closure: narrow neck

Artikel-Nr. article no.	Material material	Anbringungsart fixing type	Gewindegröße thread size	Dichtung seal	Originalitätsverschluss tamper evidence	Kindersicherung child resistance	Entgasung venting device
11337.1	PP	Schraubversion screw version	45 E	Konus cone	■	-	-
21337.1	PP	Schraubversion screw version	45 E	Konus + PTFE-Napf cone + PTFE disc	■	-	-
20671.1	PP	Schraubversion screw version	45 E	Einlage liner	■	-	-
20671.2	PP	Schraubversion screw version	45 E	Entgasungseinlage venting liner	■	-	■

CHEMIEVERSCHLÜSSE // CHEMICAL CLOSURES

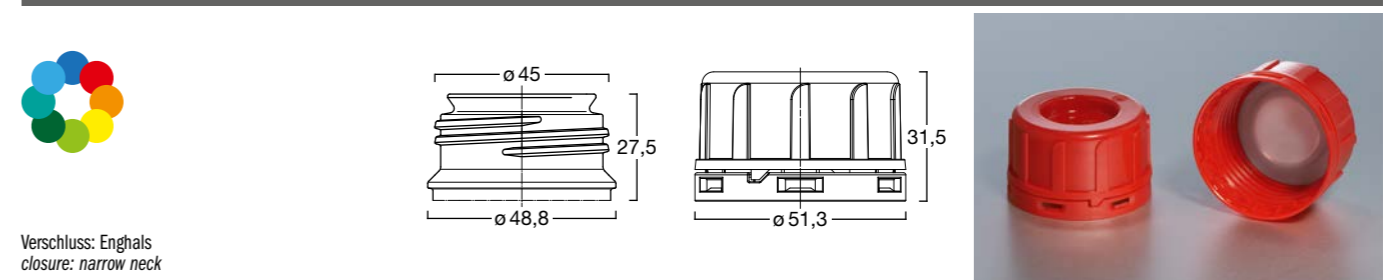

Verschluss: Enghals
closure: narrow neck

Artikel-Nr. article no.	Material material	Anbringungsart fixing type	Gewindegröße thread size	Dichtung seal	Originalitätsverschluss tamper evidence	Kindersicherung child resistance	Entgasung venting device
12817.1	PE	Schraubversion screw version	45 E	Konus cone	■	-	-
22817.1	PE	Schraubversion screw version	45 E	Konus + PTFE-Napf cone + PTFE disc	■	-	-

CHEMIEVERSCHLÜSSE // CHEMICAL CLOSURES

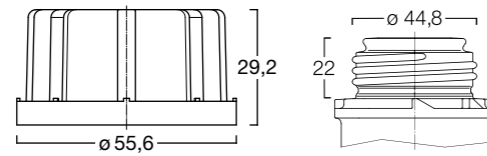

Verschluss: Enghals
closure: narrow neck

Artikel-Nr. article no.	Material material	Anbringungsart fixing type	Gewindegröße thread size	Dichtung seal	Originalitätsverschluss tamper evidence	Kindersicherung child resistance	Entgasung venting device
11864..1	PP	Schraubversion screw version	45 E	Konus cone	■	-	-
21864..1	PP	Schraubversion screw version	45 E	Konus + PTFE-Napf cone + PTFE disc	■	-	-

CHEMIEVERSCHLÜSSE // CHEMICAL CLOSURES

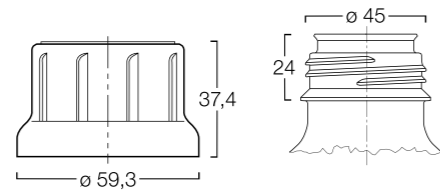

Verschluss: Enghals
closure: narrow neck

Artikel-Nr. article no.	Material Verschluss material closure	Material Ring material ring	Anbringungsart fixing type	Gewindegröße thread size	Dichtung seal	Originalitätsverschluss tamper evidence	Kindersicherung child resistance	Entgasung venting device
34404..1	PP	PP	Schraubversion screw version	45 E	PE-Dichtnapf 817 + PTFE-Napf PE-seal bowl 817 + PTFE disc	■	-	■

CHEMIEVERSCHLÜSSE // CHEMICAL CLOSURES

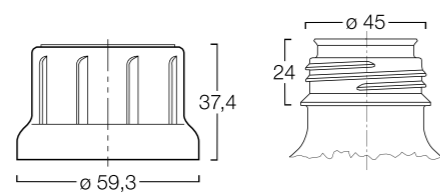

Verschluss: Enghals
closure: narrow neck

Artikel-Nr. article no.	Material Verschluss material closure	Material Ring material ring	Anbringungsart fixing type	Gewindegröße thread size	Dichtung seal	Originalitätsverschluss tamper evidence	Kindersicherung child resistance	Entgasung venting device
31401..3	PP	PP	Schraubversion screw version	45 E	PE-Dichtnapf 1284 + PTFE-Napf PE-seal bowl 1284 + PTFE disc	■	-	-
31401..2	PP	PP	Schraubversion screw version	45 E	Einlage liner	■	-	-

CHEMIEVERSCHLÜSSE // CHEMICAL CLOSURES

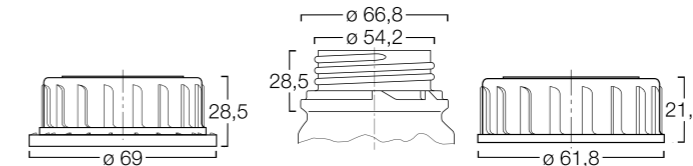

Verschluss: Weithals
closure: wide mouth



Artikel-Nr. article no.	Material material	Anbringungsart fixing type	Gewindegröße thread size	Dichtung seal	Originalitätsverschluss tamper evidence	Kindersicherung child resistance	Entgasung venting device
10698..1	PP	Schraubversion screw version	54 W	Konus cone	-	-	-
10968..1	PP	Schraubversion screw version	54 W	Konus cone	■	-	-

CHEMIEVERSCHLÜSSE // CHEMICAL CLOSURES

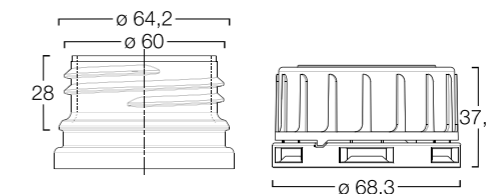

Verschluss: Weithals
closure: wide mouth



Artikel-Nr. article no.	Material material	Anbringungsart fixing type	Gewindegröße thread size	Dichtung seal	Originalitätsverschluss tamper evidence	Kindersicherung child resistance	Entgasung venting device
12746..1	PP	Schraubversion screw version	60 W	Konus cone	■	-	-
22746..1	PP	Schraubversion screw version	60 W	Einlage liner	■	-	-

CHEMIEVERSCHLÜSSE // CHEMICAL CLOSURES

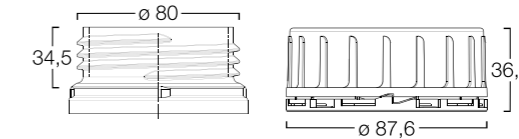

Verschluss: Weithals
closure: wide mouth



Artikel-Nr. article no.	Material material	Anbringungsart fixing type	Gewindegröße thread size	Dichtung seal	Originalitätsverschluss tamper evidence	Kindersicherung child resistance	Entgasung venting device
12747..1	PP	Schraubversion screw version	80 W	Konus cone	■	-	-
22747..1	PP	Schraubversion screw version	80 W	Einlage liner	■	-	-



CHEMIEVERSCHLÜSSE // CHEMICAL CLOSURES

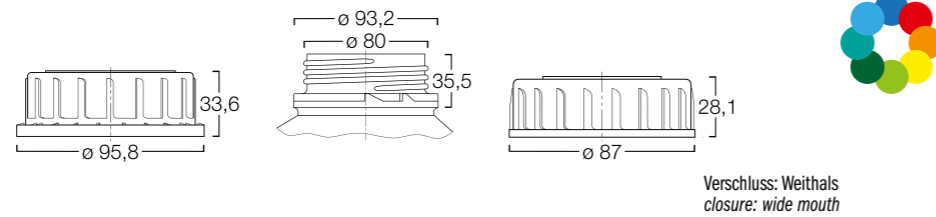

Verschluss: Weithals
closure: wide mouth

Artikel-Nr. article no.	Material material	Anbringungsart fixing type	Gewindegröße thread size	Dichtung seal	Originalitätsverschluss tamper evidence	Kindersicherung child resistance	Entgasung venting device
11524..1	PP	Schraubversion screw version	80 W	Konus cone	-	-	-
11206..1	PP	Schraubversion screw version	80 W	Konus cone	■	-	-
21523..1	PP	Schraubversion screw version	80 W	Einlage liner	-	-	-
20639..1	PP	Schraubversion screw version	80 W	Einlage liner	■	-	-

STAUBSCHUTZ-KAPPEN // PROTECTION PLUGS

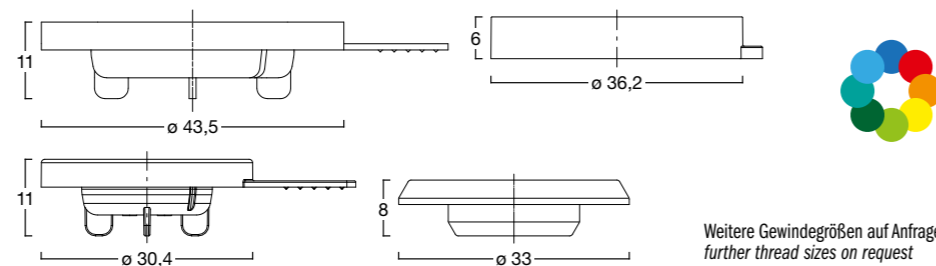

Weitere Gewindegrößen auf Anfrage
further thread sizes on request

Artikel-Nr. article no.	Material material	Anbringungsart fixing type	Mündungsgröße orifice size	Dichtung seal	Originalitätsverschluss tamper evidence	Kindersicherung child resistance	Entgasung venting device
12635..1	PE	Prellversion push on version	DIN 32	-	-	-	-
11229..1	PE	Prellversion push on version	DIN 45	-	-	-	-
11177..1	PE	Prellversion push on version	DIN 32	-	-	-	-

ÖFFNUNGSHILFEN FÜR SCHRAUBVERSCHLÜSSE // ACCESSORIES FOR SCREW CAPS

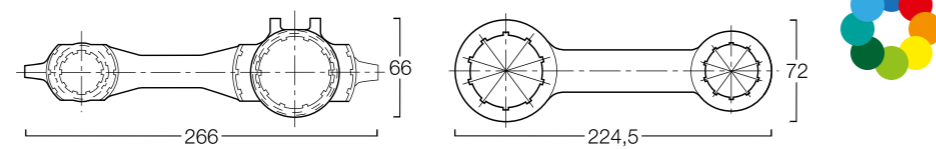

Artikel-Nr. article no.	Schlüssel für key for	Artikel-Nr. article no.	Schlüssel für key for
10166..1	DIN 32 / 45	10246..1	DIN 32 / 45 / 54 / 80

1 Originalitätssicherung
Tamper-evidence

Die Originalitätssicherung kann nur durch die entsprechende Gestaltung der Behältermündung erfüllt werden.

It should be noted that the protection function of the tamper-evident closure can only be fulfilled if the container neck is correspondingly designed.

2 Kindersicherung
Child resistance

Die Kindersicherung bezieht sich auf die Gesamtverpackung, bestehend aus Verschluss und Behältnis. Eine Prüfung sowie die Ausstellung eines entsprechenden Zertifikats ist notwendig.

It should be noted that the protection function of the child resistant device relates only to the complete packaging unit comprising closure and container, subsequent to testing and issue of a relevant certificate.

3 Be- oder Entgasung
Degassing/Venting

Die Funktion der Be- oder Entgasung wird nur bei sachgerechter Lagerung und bei sachgerechtem Transport der Gesamtverpackung erfüllt. Zwischen Entgasungsmembrane und Füllgut ist ein Luftraum notwendig.

It should be noted that the venting function can only be fulfilled by proper storage and transportation of the complete packaging unit. Allowance made for an air space between the venting membrane and the product.

4 Füllgutverträglichkeit
Compatibility of the filling contents

Eine Füllgutverträglichkeit mit unseren Produkten können wir nicht garantieren.

We cannot guarantee the compatibility of the filling contents and our products.

Kompatible Kapseln für Kaffee – und lösliche Getränke.
Perfekte Abstimmung mit dem Kunden von der Röstung
des Kaffees bis hin zur fertigen Kapsel.

Single serve coffee, Solubles, Other hot drinks.
Perfect adjustment with customers started from the
coffee roasting till production of the final cap.



KAPSEL-LÖSUNGEN // CAPSULE SOLUTIONS

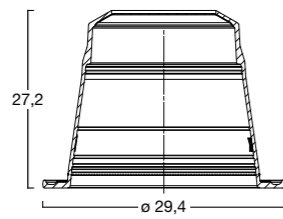

BARISTA Capsule 2.0

- High barrier
- Patented grid
- Compatible with all machines in the market

Artikel-Nr. article no.	Produktionsstandort production site	Material material	Füllvolumen filling volume	Dichtung sealing	Sonstiges others
22980..1	DE	PP/EVOH/PP	13,2 ml	Patented sealing area - diamond grid	
57010	ES	PP/EVOH/PP	13,2 ml	Patented sealing area - diamond grid	

KAPSEL-LÖSUNGEN // CAPSULE SOLUTIONS

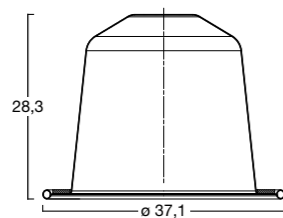

BARISTA Capsule Alu 1.0

- High barrier
- Recyclable ready

Artikel-Nr. article no.	Produktionsstandort production site	Material material	Füllvolumen filling volume	Sonstiges others
77002	ES	PP/EVOH/PP	13,25 ml	Für Kaffee for coffee

KAPSEL-LÖSUNGEN // CAPSULE SOLUTIONS

BARISTA Capsule Alu 2.0

- High barrier
- Recyclable ready

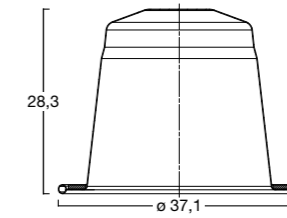

Artikel-Nr. article no.	Produktionsstandort production site	Material material	Füllvolumen filling volume	Sonstiges others
77000	ES	PP/EVOH/PP	13,25 ml	Für Kaffee for coffee

KAPSEL-LÖSUNGEN // CAPSULE SOLUTIONS

MATRYOSHKA Capsule 1.0

- No barrier
- Recyclable ready
- Suitable for coffee,
solubles, tea, etc.

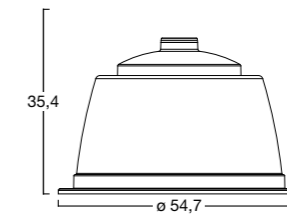

Artikel-Nr. article no.	Produktionsstandort production site	Material material	Sonstiges others
57003/05	ES	PP/EVOH/PP	Für Kaffee for coffee
57003/XX	ES	PP/EVOH/PP	Für lösliche Getränke for solubles

KAPSEL-LÖSUNGEN // CAPSULE SOLUTIONS

MATRYOSHKA Capsule 2.0

- High barrier
- Recyclable ready
- Suitable for coffee,
solubles, tea, etc.

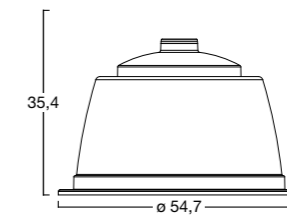

Artikel-Nr. article no.	Produktionsstandort production site	Material material	Sonstiges others
57007/01	ES	PP/EVOH/PP	Für Kaffee for coffee
57007/xx	ES	PP/EVOH/PP	Für lösliche Getränke for solubles

Für weitere Informationen fragen Sie bitte Ihre*n Ansprechpartner*in.

For further information please apply to your contact.



Erstmals bietet MENSHEN eine Produktlinie speziell für die Kosmetik-Industrie an. Eine große Auswahl an ansprechenden und eleganten Tiegeln, Dispensern und Flaschen für Tönungen, Lotionen und Cremes erweitern unsere Produkt-Range und überzeugen durch ein attraktives Preis-Leistungsverhältnis.

MENSHEN has launched its first generation of packs focused on cosmetics. This elegant packaging concepts offers various style of a high-end cosmetics range from toner and lotion to cream etc. It offers minimalistic elegance, an attractive price/performance ration and excellent production compatibility.

MENSHEN Amerika MENSHEN America

Mexiko // Mexico
MENSHEN Mexicana, S. de C.V. de R. L.
Parque Industrial Exportec
Circuito Ernesto Monroy Cárdenas, 109
Municipio de Toluca, Estado de México
Fon +52 722 2734782
Fax +52 722 2734783
contact@menshenmex.com

USA // United States
MENSHEN Packaging USA, Inc. 21
Industrial Park
Waldwick, NJ 07 463 · United States
Fon +1 201 4457436
Fax +1 201 4453473
info@menshenusa.com

MENSHEN Asien MENSHEN Asia

China // China
MENSHEN Packaging (Shanghai) Co., Ltd.
No. 885, Minyi Rd. · Xin Qiao Industrial Zone
Songjiang District
Shanghai, China, 201612
Fon +86 21 67686000
Fax +86 21 37842798
contact.china@menshen.com.cn

China // China
MENSHEN Packaging
(Guangzhou) Co., Ltd.
No.12, Xiayuan Rd.
Xiayuan Village, Yongning Street,
Zengcheng District
Guangzhou, Guangdong,
China 511358
Fon +86 20 32082000
Fax +86 21 32083343
contact.gz(at)menshen.com.cn

Singapur // Singapore
MENSHEN Packaging
Singapore Pte Ltd
3 Gambas Crescent
#08-11 Nordcom I
Singapore 757088
Fon & Fax +65 6686 2026
Mobile +65 9146 2621
contact@menshen.com.sg

MENSHEN Europa MENSHEN Europe

Deutschland // Germany
Georg MENSHEN GmbH & Co. KG
Industriestraße 26
57413 Finnentrop · Germany
Fon +49 2721 518-0
Fax +49 2721 518-198
contact@menshen.com

Deutschland // Germany
Georg MENSHEN GmbH & Co. KG
Selbecke 11
59846 Sundern-Hagen · Germany
Fon +49 2721 518-0
Fax +49 2721 518-198
contact@menshen.com

Deutschland // Germany
Georg MENSHEN GmbH & Co. KG Im
Kahley 1
58840 Plettenberg-Kahley · Germany
Fon +49 2721 518-0
Fax +49 2721 518-198
contact@menshen.com

Frankreich // France
MENSHEN Emballage
France S.A.R.L.
230 Avenue du Grain d'Or
F-41350 Vineuil
Fon +33 672 488 521
adv@menshen.com

Schweiz // Switzerland
MENSHEN Schweiz GmbH
Ringstrasse 37
6010 Kriens · Switzerland
Fon +41 41 8338866
Fax +41 41 8338869
contact@menshen.ch

Spanien // Spain
MENSHEN Iber S.L.
Polígono Industrial El Pla
Avda. Barcelona, 235
08750 Molins de Rei/ Barcelona · Spain
Fon +34 93 6803065
Fax +34 93 6802501
comercial@menshen.es

Vereinigtes Königreich // United Kingdom
MENSHEN Packaging UK Ltd.
Tec Marina
Terra Nova Way
Penarth
CF64 1SA
United Kingdom
Fon +44 2920 473147
sales@menshen.co.uk



Georg MENSHEN GmbH & Co. KG
Industriestraße 26
57413 Finnentrop · Germany

Fon +49 2721 518-0
Fax +49 2721 518-198
contact@menshen.com
www.menshen.com

